

1000 WATT AM TRANSMITTER

MODEL RA-1000 A

RAYTHEON

RAYTHEON MANUFACTURING COMPANY

Waltham 54, Massachusetts

IB8-3

Table of Contents

<u>Title</u>	<u>Page</u>
SECTION I. — DESCRIPTION	
General	1
Mechanical Construction	1
Circuit Design	1
Control Circuits	1
Power Supply Circuits	2
Audio-Frequency Circuits	3
Radio-Frequency Circuits	3
Technical Summary	4
Electrical Characteristics	4
Tube Complement	4
Mechanical Specifications	4
SECTION II. — INSTALLATION	
Location and Connections	5
Preliminary Adjustments	6
SECTION III.— OPERATION	
SECTION IV. — MAINTENANCE	

List of Illustrations

<u>Figure</u>		<u>Page</u>
0	(Frontispiece) Raytheon AM Transmitter, Model RA-1000A	0
1.	Front View	12
2.	Rear View	13
3.	H.V. Power Supply & Mod. Comp.	14
4.	Rear View (Left Side)	15
5.	RF Power Amplifier & Driver	16
6.	Rear View (Right Side)	17
7.	Control Panel (Rear)	18
7A.	Front View (Lower Panel Removed)	19
8.	Side View (Left)	20
9.	AF. Amplifier Chassis (Top)	21
10.	AF. Amplifier Chassis (Bottom)	21
11.	Modulator Bias Supply (Top)	22
12.	Modulator Bias Supply (Bottom)	22
13.	Exciter Chassis (Top)	23
14.	Exciter Chassis (Bottom)	23
15.	H.V. Rectifier Chassis (Top)	24
16.	H.V. Rectifier Chassis (Bottom)	24
17.	Modulator Power Supply (Top)	25
18.	Modulator Power Supply (Bottom)	25
19.	RF Driver 813 Tube Chassis (Top)	26
20.	RF Driver 813 Tube Chassis (Bottom)	26
21.	Physical Layout—Outline Drawing	27
22.	Base Plate Wiring Diagram	28
23.	Conduit Holes & Proposed Wiring Layout	29
24.	1 Kw. A.M. Transmitter (Schematic)	31

Warning

This equipment contains high voltages which may endanger human life if improperly handled. The doors are provided with high voltage interlock switches as a protective measure and these switches should not be disturbed. The power should be removed completely before changing tubes or making internal adjustments.

Every effort has been made in the design to eliminate danger to personnel. Raytheon accepts no responsibility for any injury or loss of life suffered in connection with this equipment.

RA-1000A Transmitter

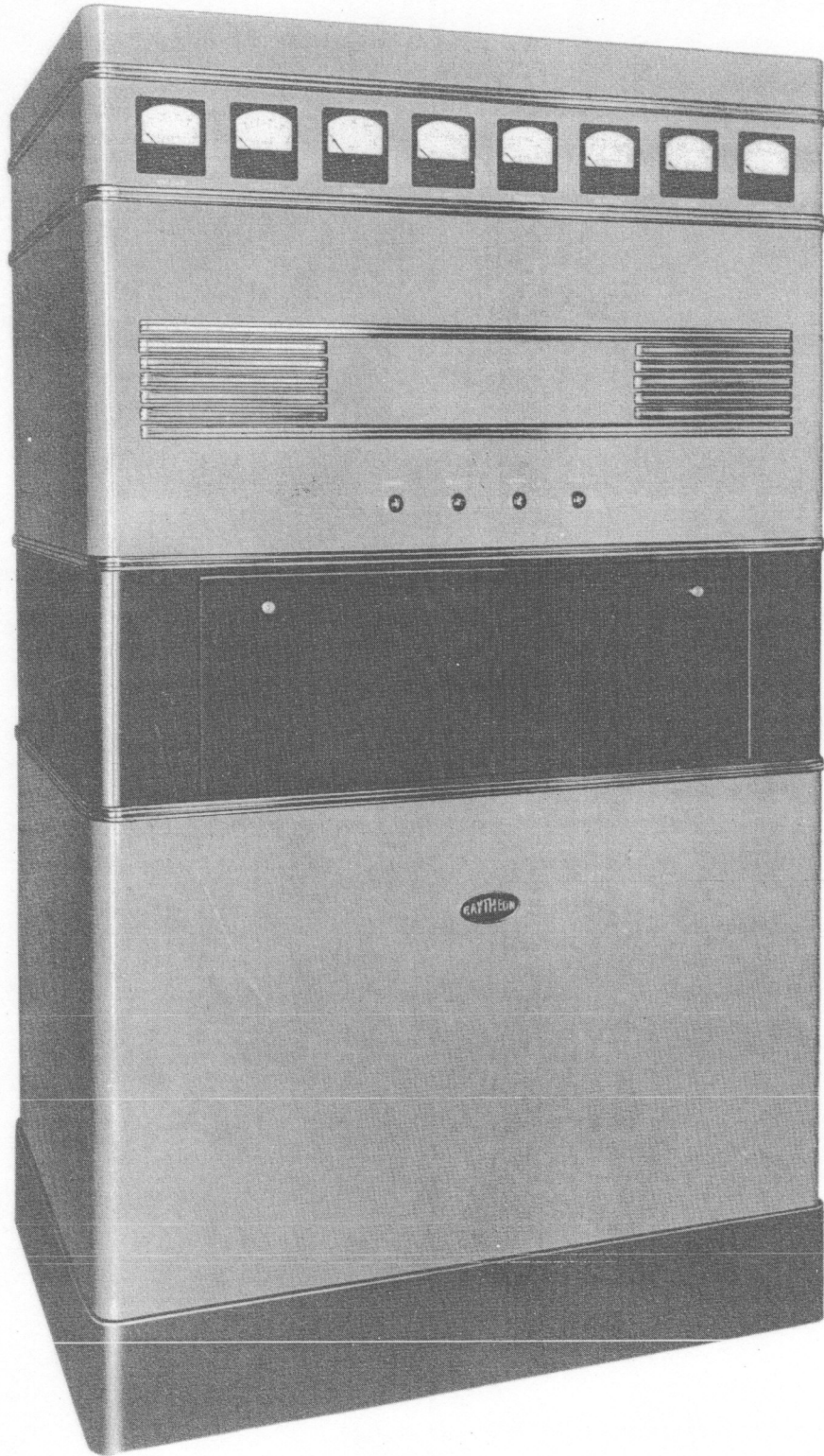

Raytheon 1000 Watt AM Transmitter,
Model RA-1000A

SECTION 1 DESCRIPTION

GENERAL.

The RA-1000A Transmitter is designed to operate at any frequency between 540 and 1600 kc. It will deliver its rated power into a 70- to 250-ohm transmission line and provide reliable high-fidelity operation with negligible distortion and carrier noise.

The equipment operates from a 210-230-volt 50-60 cycle 3-wire single-phase power line. All transformers have 210-, 220-, and 230-volt taps readily accessible for the various power-line voltages encountered.

MECHANICAL CONSTRUCTION.

The complete Transmitter is assembled into one spacious cabinet in such a way that all components are readily accessible for inspection and servicing if necessary. Chassis construction is used wherever possible for isolation of circuits and to facilitate servicing.

The Transmitter is built within an inner cabinet. The wiring is run between the walls and is readily accessible behind hinged side panels or easily removable front panels. This construction provides a unit that is neat and rugged yet easily accessible for inspection. The rear of the cabinet is protected by two large doors, the opening of which will operate high-voltage interlock switches.

CIRCUIT DESIGN.

Control Circuits.

The control circuits serve to provide convenient operation and adequate protection to the tubes and other components. All power supplies have fuses or other overload protection. All controls necessary for operation are located on a recessed panel.

RA-1000A Transmitter

On this panel are six sets of push buttons. On the left are the Filament Start and Stop Buttons, the former placing the Transmitter in the standby condition. In the center are four sets of push buttons that control the reversible motors driving the r.f. tuning circuits. On the right are the Plate Start and Stop Buttons that control the high-voltage power supplies.

The Filament Control (rheostat 7R-1) adjusts all filaments to take care of slight power-line voltage changes. The Plate Control (rheostat 7R-2) adjusts the power input to the r.f. power amplifier to maintain correct carrier level. Also located on the control panel are switches to select crystals and r.f. transmission lines feeding the antenna, and also the neutralizing R.F. Pickup Jack and neutralizing adjustment (marked Neut.Cond.).

The liberal provision of meters helps facilitate all adjustments. Five meters, located on the control panel, are in the low-power r.f. and a.f. circuits. Eight large easy-to-read meters near the top of the cabinet are connected in the modulator, r.f. power amplifier, and antenna circuits.

Four pilot lights, Filament, Crystal 1, Crystal 2, and Plate, are located above the control panel and are visible at all times.

Power Supply Circuits.

A 350-volt power supply, using a 5U4G rectifier and assembled on the r.f. exciter chassis, supplies power to the 6J5 crystal oscillator and the 807 buffer amplifier. The audio amplifier power supply chassis uses a 5U4G rectifier and supplies 350 volts to the push-pull 6J7 and 6J5 tubes. A separate filament transformer on this chassis supplies the push-pull 845 tubes. The modulator bias supply, using two 5U4G rectifier tubes, supplies a variable voltage to the class B 833A modulator grids and a fixed bias of 60 volts for the 813 r.f. driver tubes.

Two 575A rectifier tubes supply 2750 volts to the r.f. power amplifier and the class B modulator tubes. An intermediate power supply, using two 866A rectifiers, supplies 1500 volts for the push-pull 813's and push-pull 845 tubes. Switch 6S-6, located

in the rear of the Transmitter (Fig. 2) permits operation of the Transmitter at reduced plate voltage on the power amplifier and modulator tubes for initial tuning and test.

Audio-Frequency Circuit.

The a.f. amplifier consists of four stages of push-pull amplification with an essentially flat response from 30 to 10,000 cycles. It is designed for 500-600-ohm balanced-line zero level db. input (1 milliwatt reference level). The first two push-pull stages consist of 6J7 tubes resistance-coupled to push-pull 6J5 tubes and resistance-coupled to push-pull 845 driver tubes. A transformer is used between the push-pull 845's and the class B. 833A modulator tubes. Negative feedback is connected over the last three stages, which greatly improves the frequency response and distortion. The Transmitter will work satisfactorily without the feedback network in case some trouble arises. There is ample power available for 100% modulation with negligible distortion.

Radio-Frequency Circuit.

Excellent frequency stability is attained by the use of temperature-controlled low temperature coefficient crystals connected in the conventional triode oscillator circuit using a 6J5 tube. Vernier frequency control is obtained by an adjustment of capacitor 1C-3 or 1C-4 (depending on the crystal in use). There are two stages of r.f. amplification between the crystal oscillator and the power amplifier. The first r.f. amplifier is an 807 tube (class A) which reduces the possibility of any frequency drift due to loading of the crystal oscillator tube. The second r.f. amplifier consists of two 813 tubes in push-pull, which have more than sufficient available power to drive the 833A power amplifier tubes. There are three tuned tank circuits and a variable r.f. line pickup coil.

RA-1000A Transmitter

TECHNICAL SUMMARY

Electrical Characteristics

Type of emission:	Telephone
Carrier output:	1000 watts
Frequency range:	540-1600 kc.
Power supply:	210-230 volts 50-60 cycles 3-wire single-phase
Power consumption (for 100% modulation):	5000 watts
R.F. stability:	+10 cycles
Modulation:	100% high level
Audio input (500-600-ohm source) for 100% modulation:	Zero level db. for 1-milliwatt reference level
Average program level:	-5 db. (1-milliwatt reference level)
Audio-frequency response:	+1 db. from 30-10,000 cycles
Audio distortion (50-7500 cycles):	Less than 2-1/2% r.m.s. for 95% modulation
Noise level:	More than 60 db. below 100% modulation
Carrier shift:	Less than 3% from 0-100% modulation, 50-7500 cycles
Output circuit:	Designed to feed 70-250-ohm transmission lines

Tube Complement

Crystal oscillator:	6J5 (metal)
Buffer:	Class A 807
R.F. driver:	Push-pull 813's
R.F. power amplifier:	Push-pull 833A's
First audio:	Push-pull class A 6J7's
Second audio:	Push-pull class A 6J5's
Audio driver:	Push-pull class A 845's
Modulator:	Push-pull class B 833A's
R.F. exciter power supply:	350 volts 200 ma. full wave 5U4G
Low-level audio power supply:	350 volts 200 ma. full wave 5U4G
Modulator bias power supply:	80 volts 400 ma. full wave, two 5U4G's
R.F. and audio driver power supply:	1500 volts 425 ma., two 866A's
High-voltage power supply	2750 volts 1.2 amps., two 575A's

Mechanical Specifications

Height:	84 inches
Depth:	34-1/4 inches
Width:	48-1/2 inches
Floor area:	11-1/2 sq. ft.
Weight:	2450 pounds

SECTION 2 INSTALLATION

LOCATION AND CONNECTIONS.

The location of the Transmitter should be carefully selected and provisions made for the external connections. There should be ample space around the cabinet to allow for plenty of air circulation and to facilitate inspection and servicing when necessary. It is important that the Transmitter cabinet be securely grounded. For this purpose, a heavy copper strip connected to a good ground or buried counterpoise is recommended. Provisions for the antenna feed lines are at the top of the cabinet.

The Transmitters are ordinarily shipped with the stationary contacts of relay 2K-1 wired to the two feed-through insulators in the top of the cabinet, through the thermocouple of the R.F. Line Meter. One side of the antenna coupling coil 2L-5 is grounded directly to the top of the cabinet. The transmission line can be connected to one insulator and the ground connection. If desired, a dummy antenna load may be connected to the other insulator and ground. If it is desirable to run the coaxial cables directly into the Transmitter, they may be connected through the two holes directly above 2K-1 and the internal wiring changed for this type of installation. The 3-wire single-phase 210-230-volt a.c. line can be brought in through holes in the rear or bottom of the cabinet and connected to terminal block 6TB-1, located on the left side of the Transmitter. Access to this large terminal block is made by loosening the four half-turn fasteners along the rear of the side panel and opening it like a door. Terminal block 6TB-2 has provisions for connecting wires to four remotely located push buttons to control the main power to the Transmitter.

RA-1000A Transmitter

The station frequency monitor is connected through a 70-ohm line to terminals G and H on terminal block 1TB-2, on the r.f. exciter chassis. On terminal block 6TB-7 (located inside the cabinet near the top on the left side), terminals A and B are for audible monitoring purposes and terminals C and D should be connected to the station modulation monitor through a 70-ohm line. The wiring to the monitoring equipment can be brought in through holes in the rear of the Transmitter base. A balanced a.f. line should be brought through the bottom or rear holes and connected to 3TB-1, terminals A, B, and C. Terminal B is the shield (ground) connection.

As soon as power is applied to terminal block 6TB-1, the Crystal Indicator Lamps should light, indicating that the crystal ovens are heating. After reaching operating temperature, the lamps will go on and off periodically.

PRELIMINARY ADJUSTMENTS.

(1) Press the FILAMENT START Button. This closes the main power contactor relay 6K-6, which is protected by thermal overload switches 6S-1 and 6S-2.

(2) Adjust the FILAMENT Control (rheostat 7R-1) until the a.c. FILAMENT voltmeter reads 10 volts. (This reading should be obtained with the control advanced about halfway.)

Note

This rheostat controls all the filaments. When the meter reads 10 volts; all tubes will have their rated filament voltages. If this reading cannot be obtained, the a.c. power line should be measured and the taps on all the transformers changed to correspond to the line voltage available at 6TB-1.

Important

The equipment should be allowed to operate with the crystal oven heating power applied for at least 24 hours before attempting any frequency adjustments.

(3) Adjust capacitor 1C-3 or 1C-4 (located directly beneath the crystal in use) until the crystal frequency zero-beats with a previously calibrated frequency monitor. Note the readings on the OSCILLATOR PLATE, BUFFER PLATE, and R.F. DRIVER GRID Meters — they should be approximately as given in the table under Operation.

(4) Adjust 5R-3 for a reading of 60 volts between terminal E on 5TB-1 and the chassis.

RA-1000A Transmitter

(5) Adjust 5R-1 and 5R-2 until there is approximately -70 volts on the grids of each of the 833A modulator tubes. This can be measured directly on each grid or on terminals G and H on terminal block 5TB-1.

(6) Place switch 6S-5 in the "Off" position, and switch 6S-6 in the "Test" position. 6S5 removes the high voltage from both the power amplifier and modulator tubes and places the Transmitter in readiness for neutralizing.

(7) Make sure that a warmup period of 30 minutes has elapsed to drive all mercury vapor from the filaments of rectifier tubes 575A and 866A, and to stabilize the temperature of the crystal ovens sufficiently for test purposes.

(8) Press the PLATE START Button. This closes contactor relay 6K-5, provided that the following conditions have been met:

- (a) Rear doors are closed, operating interlock switches 6S-3 and 6S-4.
- (b) Modulator bias supply voltage has closed relay 6K-3.
- (c) No excessive overload is operating overload relays 6K-1 and 6K-7.
- (d) Time-delay relay 6K-4 has operated.

(9) Tune the 813 grid and plate circuits by pressing either the upper or lower push button, depending on which direction it is necessary to adjust for maximum final grid current. Note the reading on the R.F. DRIVER PLATE and FINAL GRID Meters; these readings should be approximately the values given in the table under Operation.

(10) Connect a neutralizing indicator (which may be a 1.5-volt 60-ma. pilot light or a vacuum tube voltmeter) to the R.F. PICKUP Jack (located on the control panel). Adjust the 833 PLATE Tune Controls for maximum reading on the r.f. indicator. Adjust the NEUT. COND. Control with a screwdriver for minimum reading on the r.f. indicator.

Note

This procedure should be repeated until the lowest possible indication is reached on the r.f. indicator.

(11) Check the adjustment of the 813 PLATE Tune Controls for a maximum reading on the FINAL GRID Meter. Adjust 6R-3 (located near the 813 chassis), which adjusts the 813 screen voltage, until the FINAL GRID Meter reads approximately 160 ma.

The Transmitter has now been neutralized and sufficient grid power applied to the 833A r.f. tubes.

RA-1000A Transmitter

(12) Push the PLATE STOP Button; this removes the plate power.

(13) Set switch 6S-5 to the "On" position.

(14) Connect either the antenna or a dummy r.f. load to the Transmitter.

(15) Push the PLATE START Button, and adjust the 833 PLATE Tune Control for a minimum reading on the FINAL PLATE Current Meter.

(16) Push the PLATE STOP Button (removing plate power).

(17) Set switch 6S-6 to the "Operate" position.

(18) Push the PLATE START Button, and adjust the PLATE Control (rheostat 7R-2) until the FINAL PLATE Voltmeter reads 2500 volts. (This reading should be obtained with the control advanced about halfway.)

Note

It may be necessary to change the primary tap on 6T-4 to bring the voltage within the prescribed setting of this rheostat.

(19) Adjust the ANTENNA Tune Control until the FINAL PLATE Current Meter reads 560 ma.

Note

The above values of voltage and current are approximately correct for 1-kw. output.

(20) Adjust 5R-1 and 5R-2, located on the modulation bias supply chassis, until the MODULATION PLATE Current Meters each show a static reading of 50 ma.

(21) Connect a 250-volt d.c. meter across the output of the a.f. driver bias supply. The meter should read 195 volts; if not, adjust resistor 4R-2, located beneath the audio power supply chassis, until this reading is obtained.

(22) With the equipment turned off, connect a 2000-volt d.c. meter between the slider on resistor 6R-5 and ground. Turn on the equipment and note the meter reading; it should be 1450 volts for the plate voltage of the a.f. driver tubes. If not, the slider should be adjusted (several times if necessary) until this reading is obtained.

WARNING

The equipment must be turned off before the slider is adjusted.

(23) Feed an audio signal (sine wave) of zero level db. into terminals A, B, and C on terminal board 3TB-1. This signal level should produce 100% modulation of the r.f. carrier, as read on the external modulation monitor.

RA-1000A Transmitter

(24) Check the adjustment of overload relay 6K-1, controlled by resistor 6R-8 (located beneath the relay). Under normal operating conditions, the contacts of overload relays 6K-1 and 6K-8 should both remain closed. The overload currents required to open these relay contacts and open the plate power contactor 6K-5 are:

6K-1	— High-voltage overload:	1.2 amps.
6K-8	— R.F. overload:	0.750 amp.

SECTION 3 OPERATION

It is assumed that the Transmitter is properly installed and adjusted and that power has been connected for at least 24 hours.

(1) To start the Transmitter, press the FILAMENT START Button, on the control panel. The meters should read as follows:

FILAMENT	- 10 volts
OSC. PLATE	- 8 ma.
BUFFER PLATE	- 55 ma.
R.F. DRIVER GRID	- 5 ma.

(2) After 30 seconds or more, press the PLATE START Button. The meters should read as follows:

R.F. DRIVER PLATE	- 110 ma.
A.F. DRIVER PLATE	- 160 ma.
MOD. PLATE	- 50 ma.
MOD. PLATE	- 50 ma.
FINAL GRID	- 160 ma.
FINAL PLATE	-2500 volts
FINAL PLATE	- 560 ma.
R.F. LINE	- Depends on trans- mission line impedance
ANTENNA	- Depends on antenna design

(3) The Transmitter is now ready to operate and audio modulation may be applied.

CAUTION

The Transmitter should always be turned on and off by its own START and STOP Buttons. If a main line switch is used between the power source and the Transmitter, it should be left on at all times. If it is ever necessary to turn this switch off, it should be turned on again at least 24 hours before Transmitter operation is attempted.

This precaution is taken to allow sufficient crystal warmup time.

SECTION 4 MAINTENANCE

Once the equipment is properly installed, it will provide reliable trouble-free operation for long periods of time.

It is important that the Transmitter be kept clean and free from dust, particularly the variable capacitors and insulators.

A regular check should be made of all tubes. Any tube showing impaired filament emission should be replaced. Care should be taken with mercury-filled tubes to see that they are kept in an upright position and that no mercury is splashed on the tube elements. Tubes of this type that have been shaken or tipped should be preheated before being placed into service. Tube prong and socket contacts should be given periodic inspection.

The equipment should be inspected periodically for poor contacts and loosened switch connections. Connections and contacts should be cleaned regularly and all mechanical connections such as bolts, nuts, and screws should be kept tight.

The tuning motors should be lubricated every six months with a light grade of machine oil. Place the oil directly on the felt washers over the motor shaft.

The armature pole pieces on relays 6K-5 and 6K-8 should be checked and cleaned periodically. The contacts of crystal switching relay 6K-1 should be burnished lightly about once a month.

The ball gap setting for filter chokes 6L-1 and 6L-2 should be 0.062"; for transformer 6T-1 and modulation reactor 6L-7 it should be 0.200".

RA-1000A Transmitter

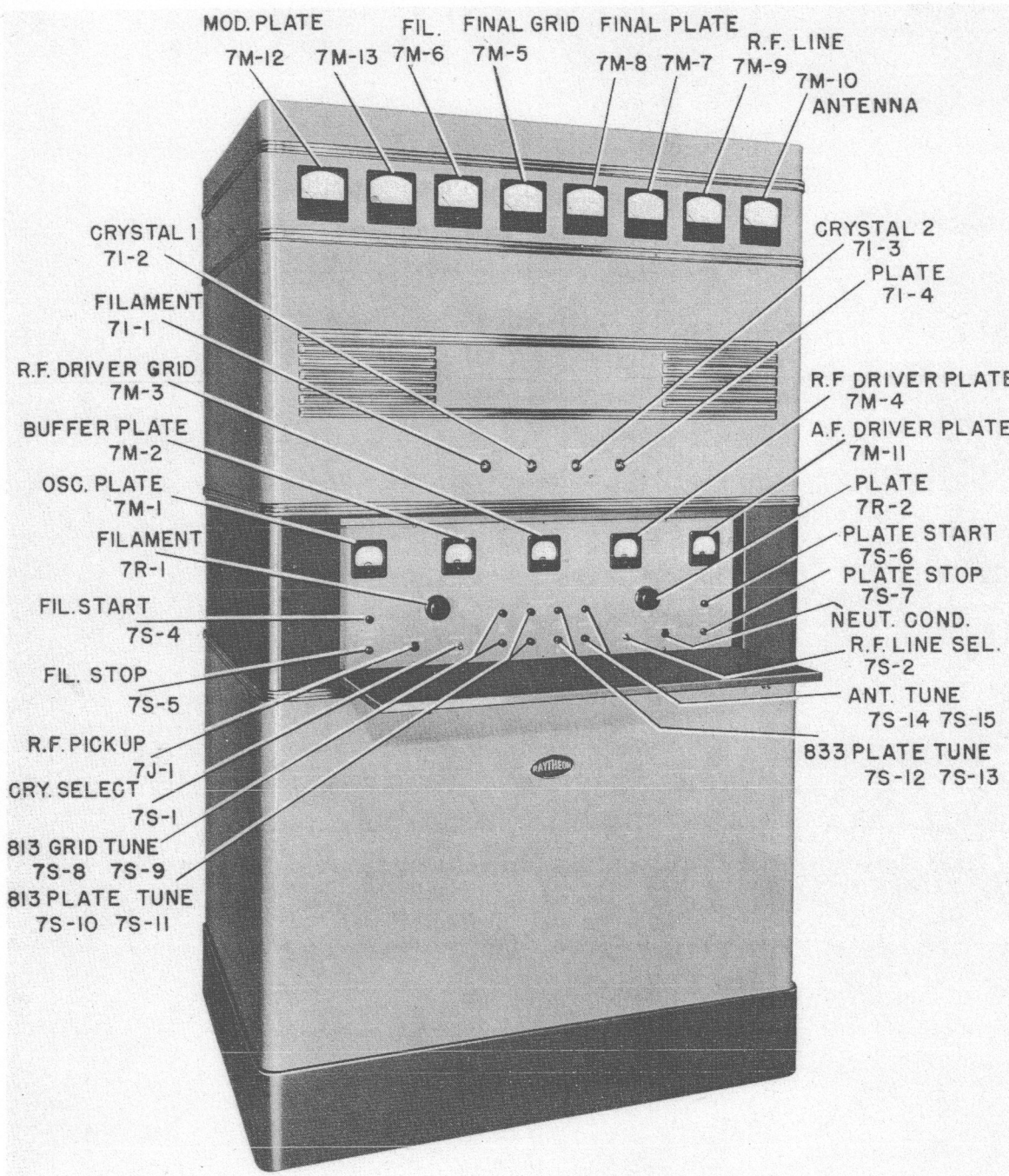

Figure 1. — Front View.

RA-1000A Transmitter

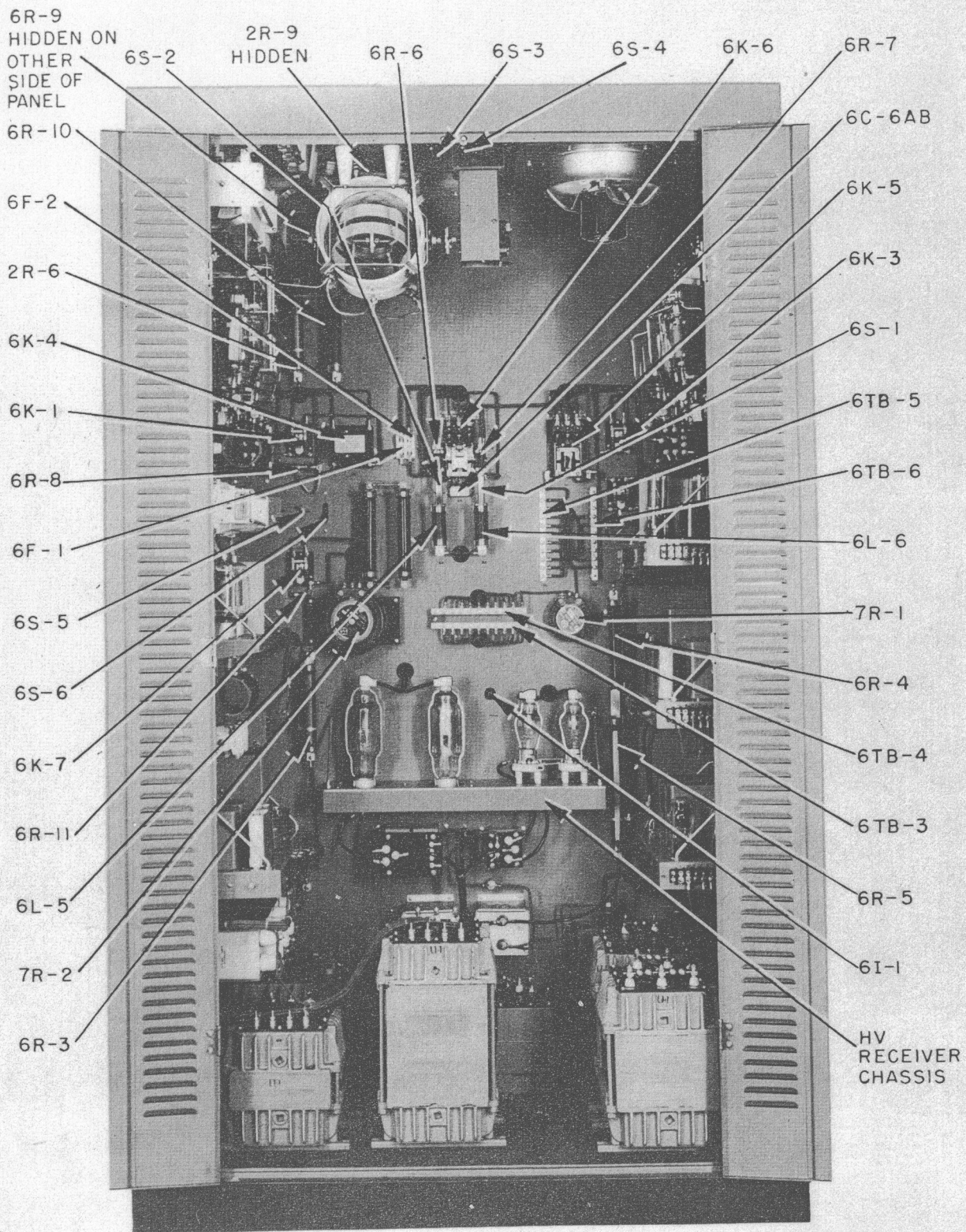

Figure 2. — Rear View.

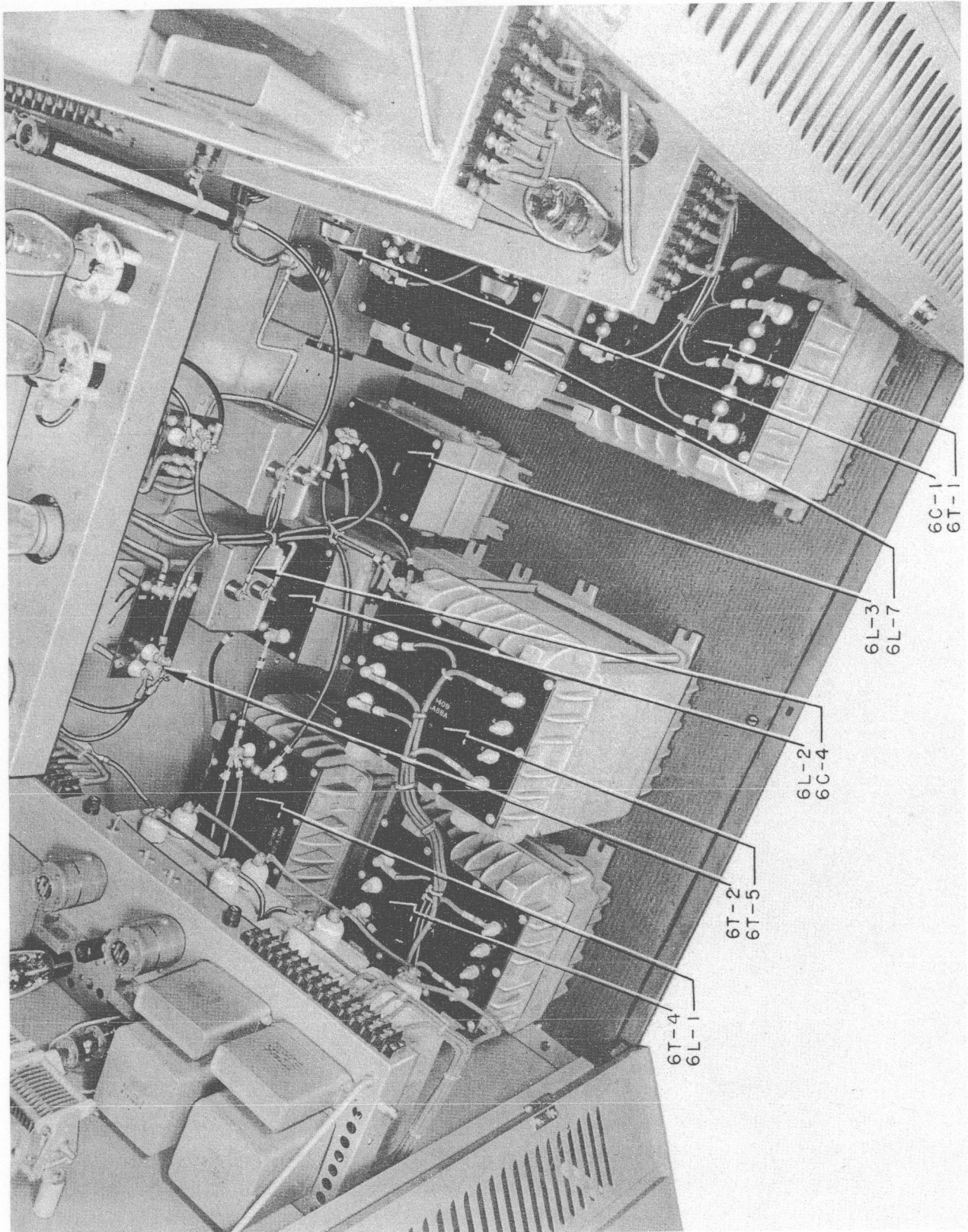

Figure 3. — H.V. Power Supply & Mod. Comp.

RA-1000A Transmitter

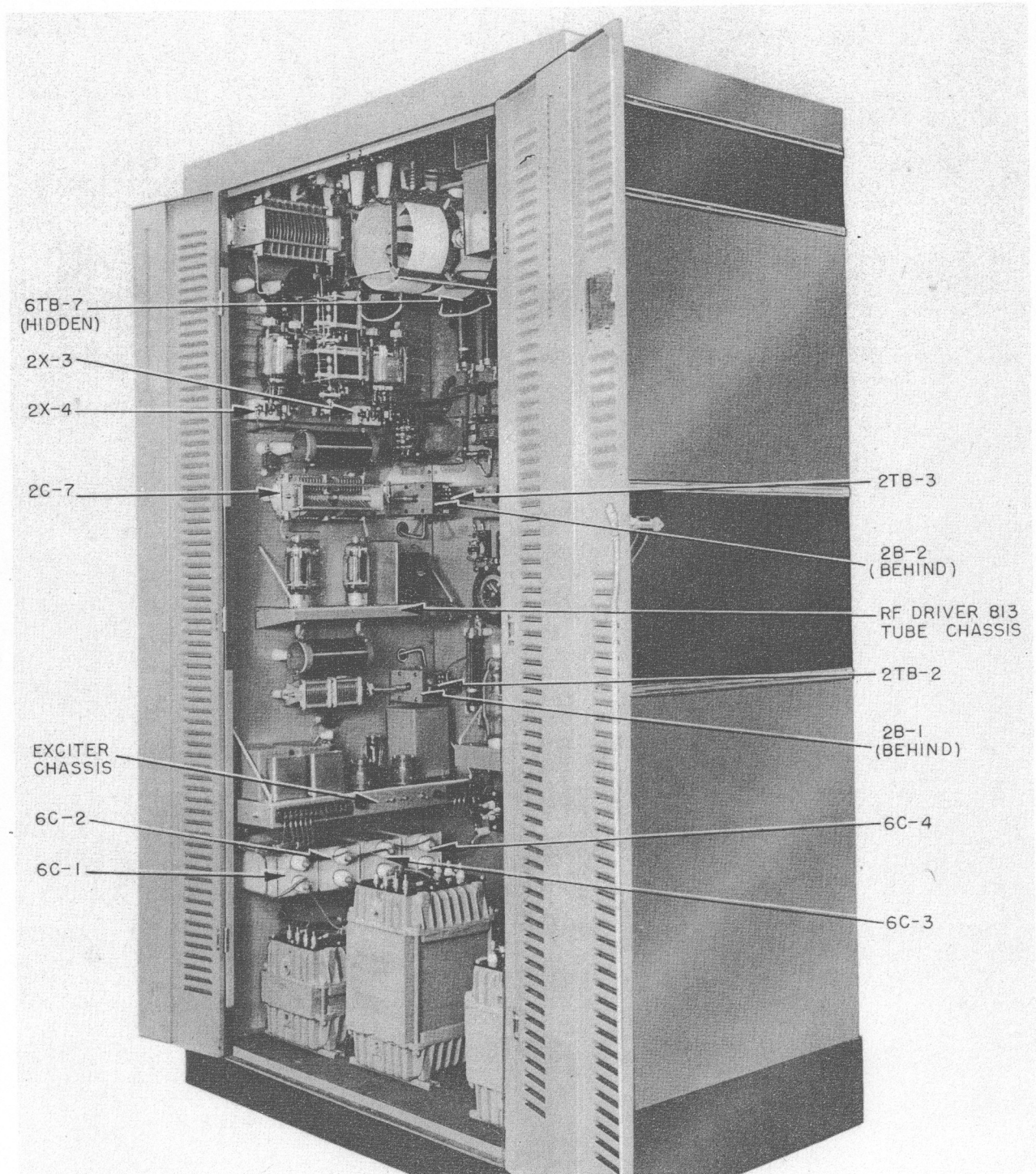

Figure 4. — Rear View (Left Side).

RA-1000A Transmitter

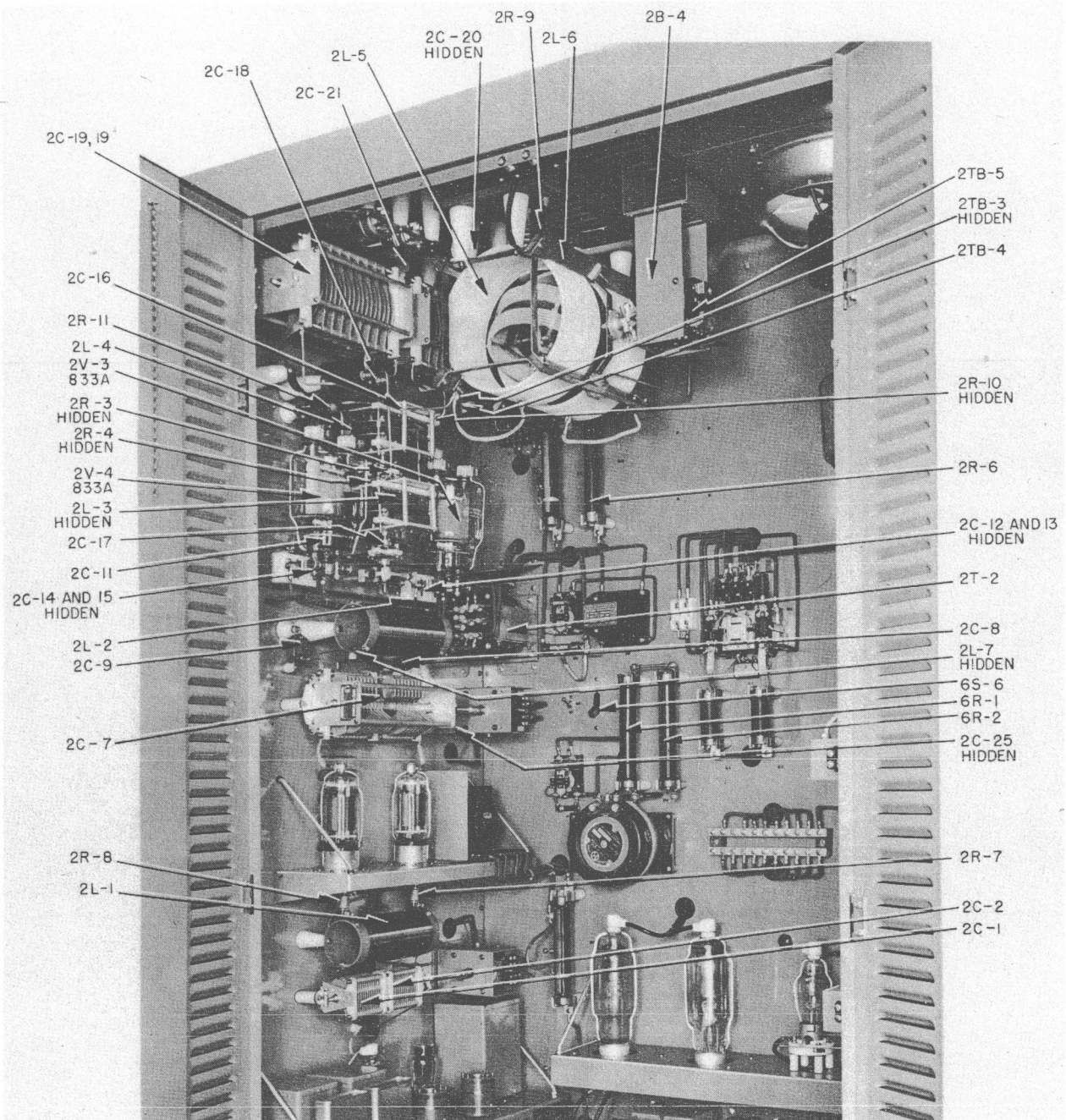

Figure 5. — RF Power Amplifier & Driver.

RA-1000A Transmitter

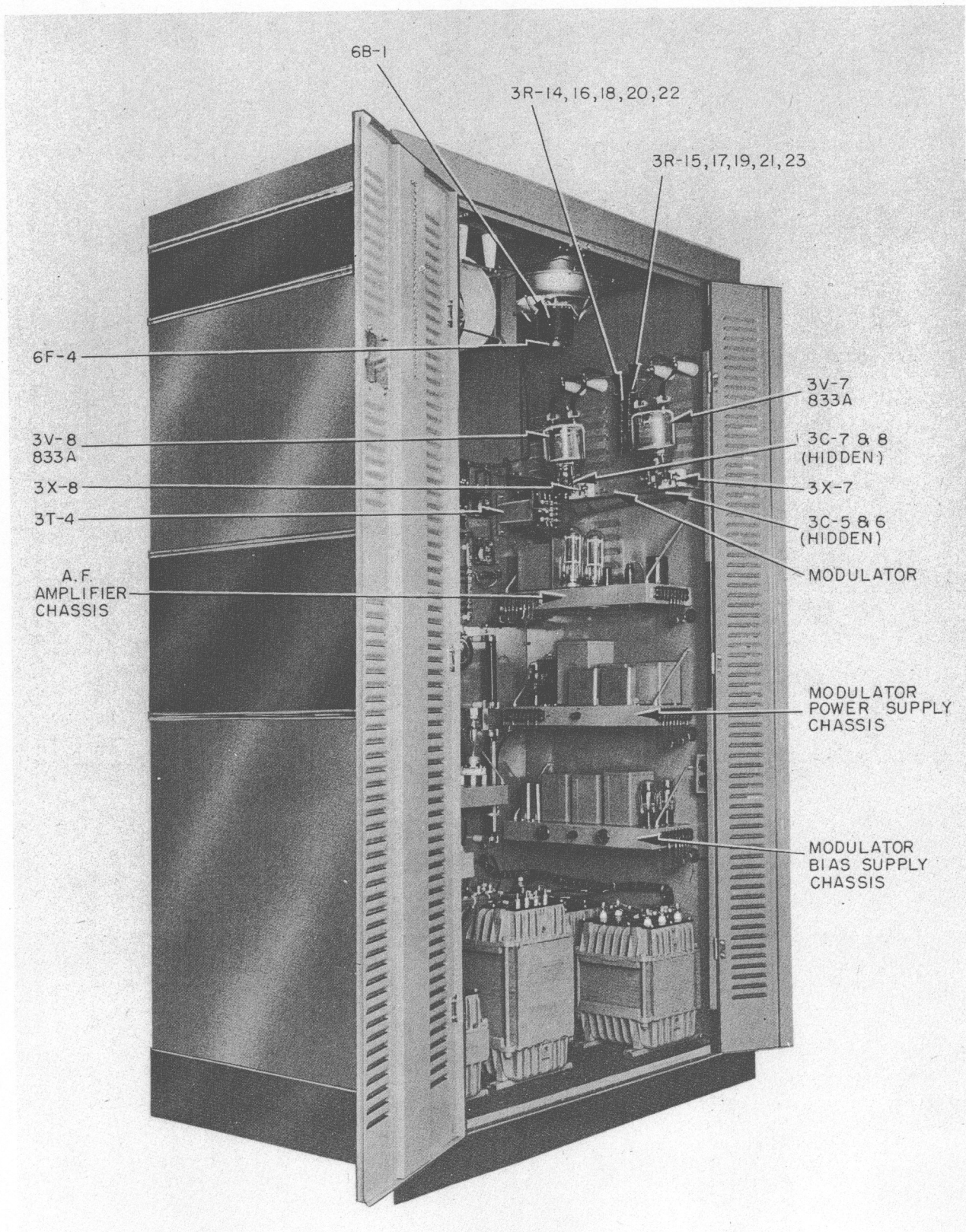

Figure 6. — Rear View (Right Side).

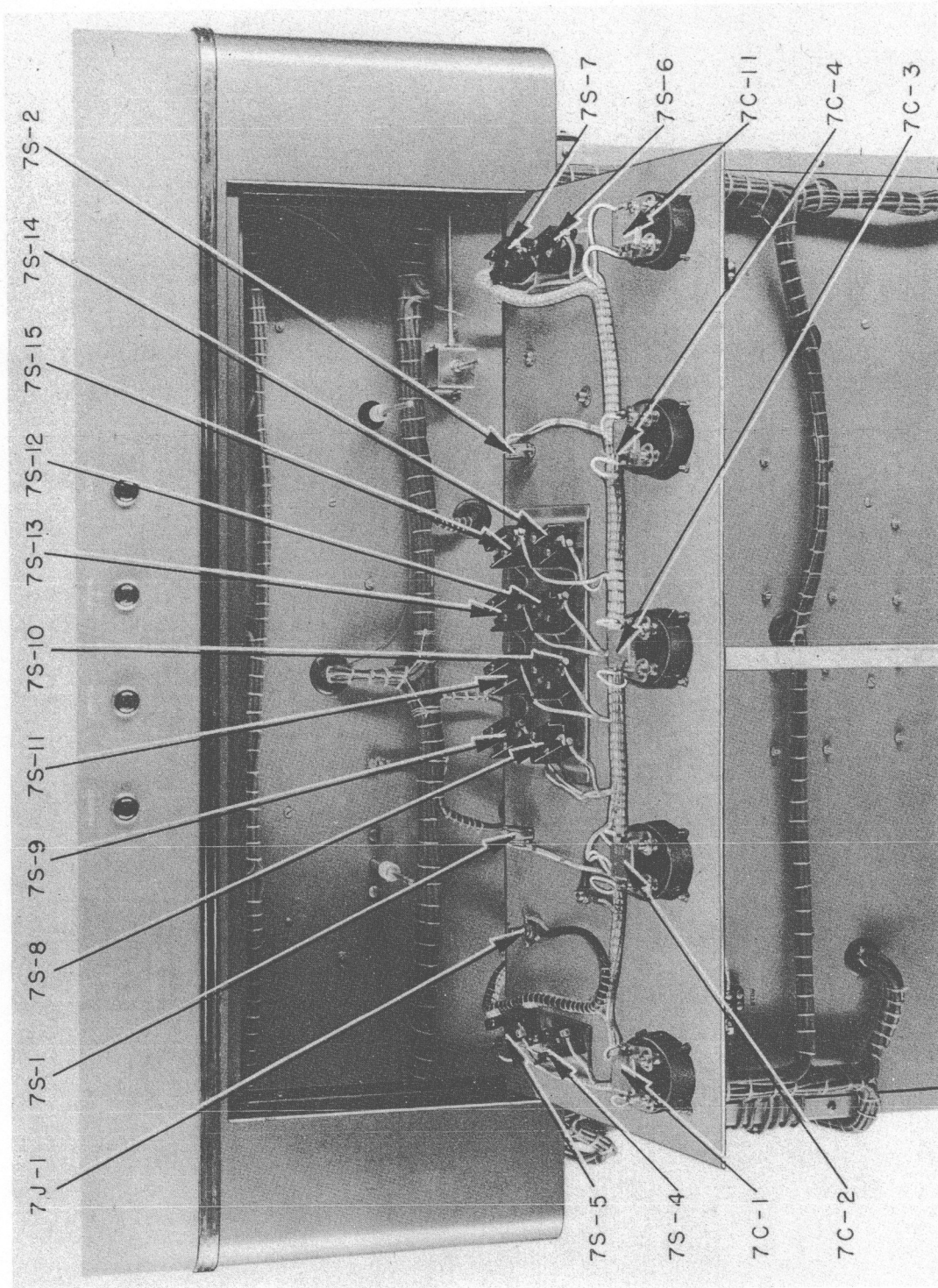

Figure 7. — Control Panel (Rear).

RA-1000A Transmitter

KD50EI

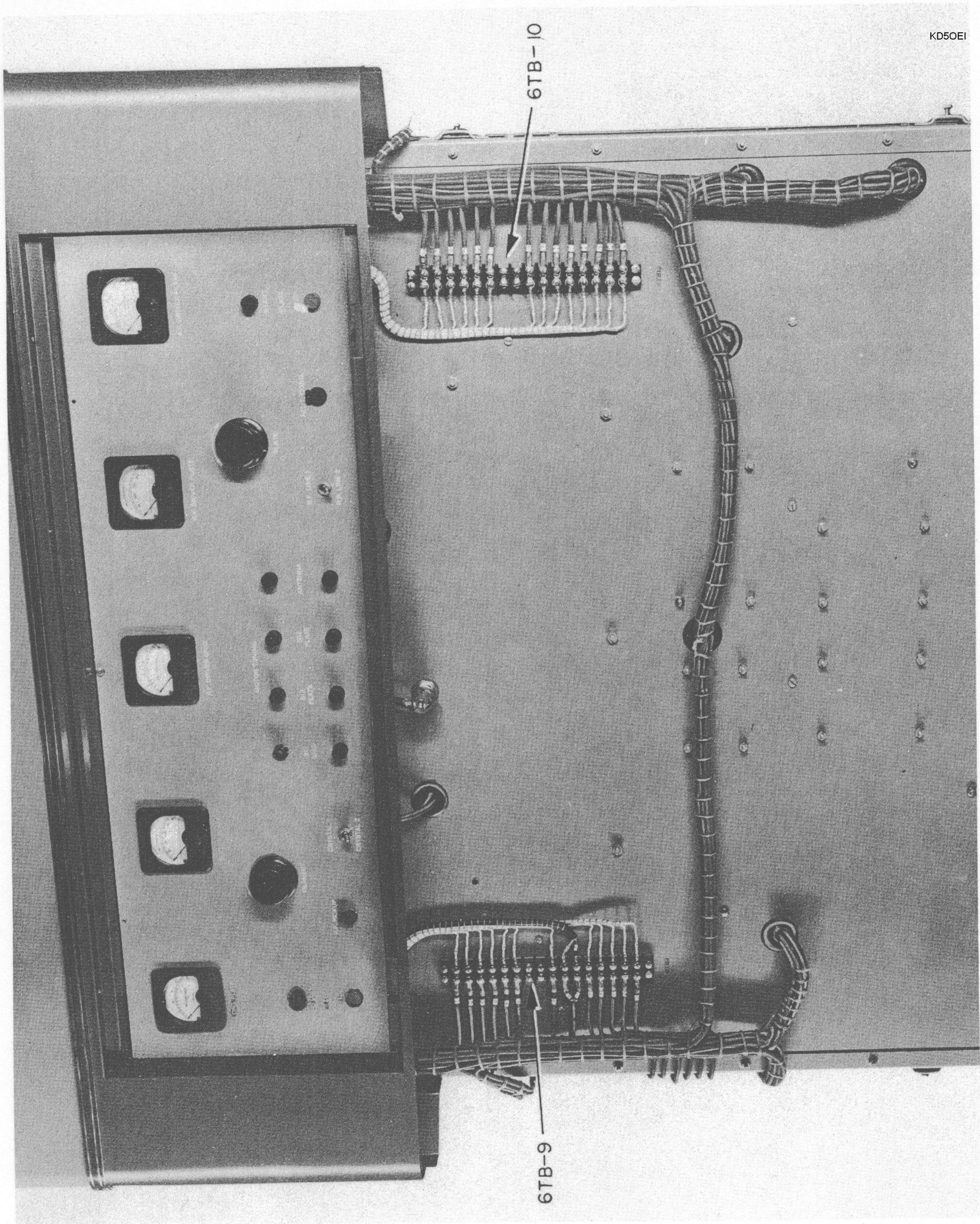

Figure 7A. — Front View (Lower Panel Removed).

RA-1000A Transmitter

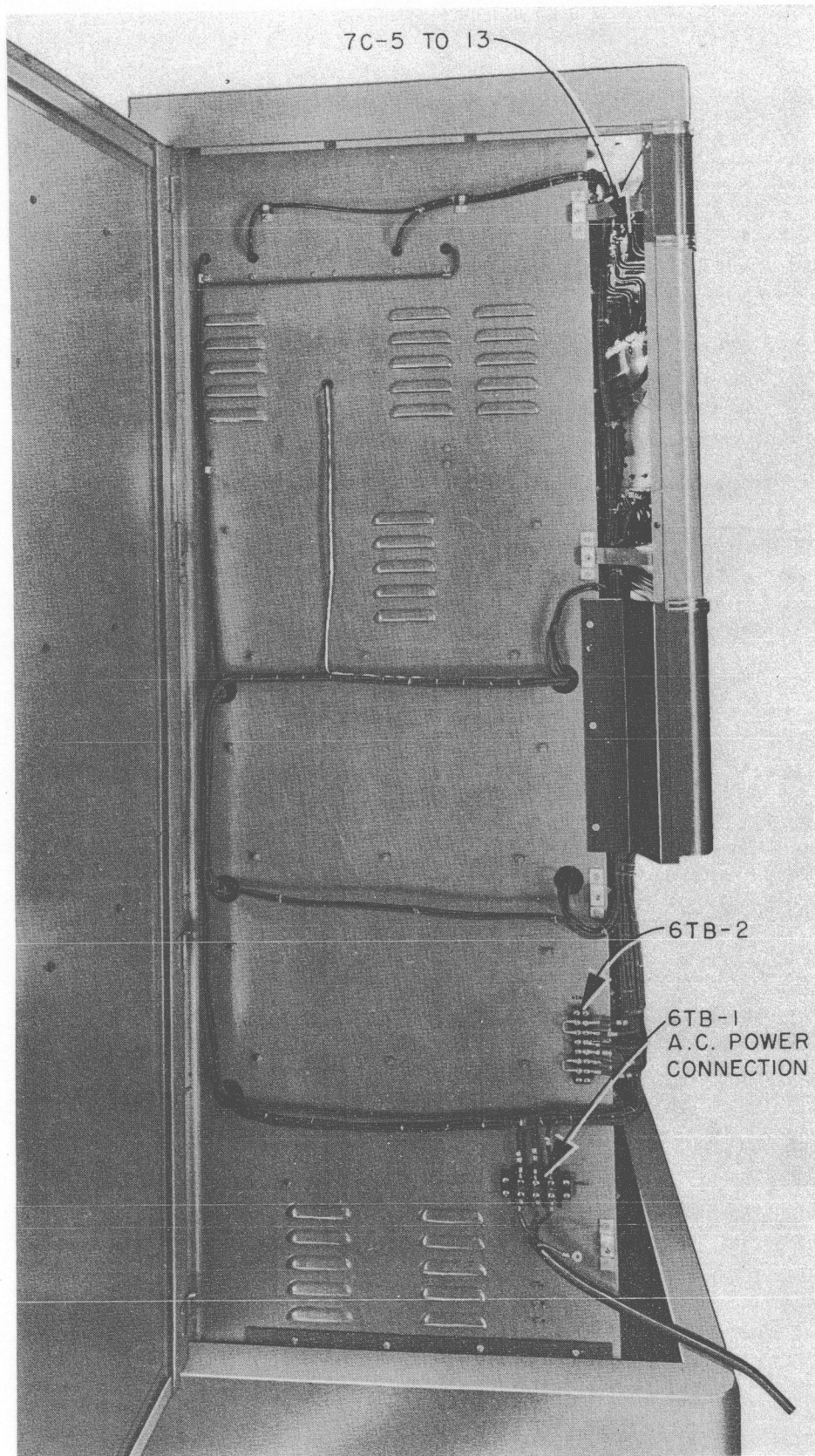

Figure 8. — Side View (Left).

RA-1000A Transmitter

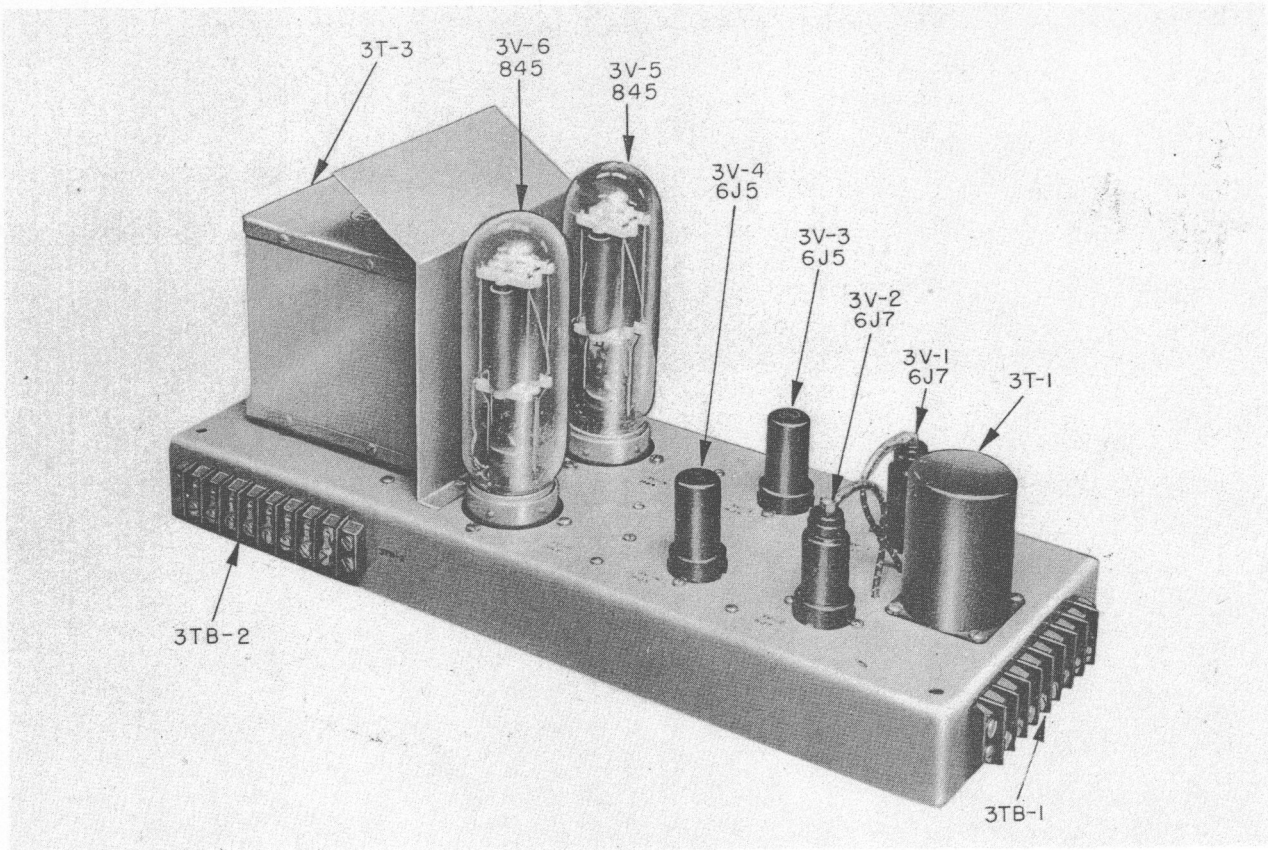

Figure 9. — AF Amplifier Chassis (Top).

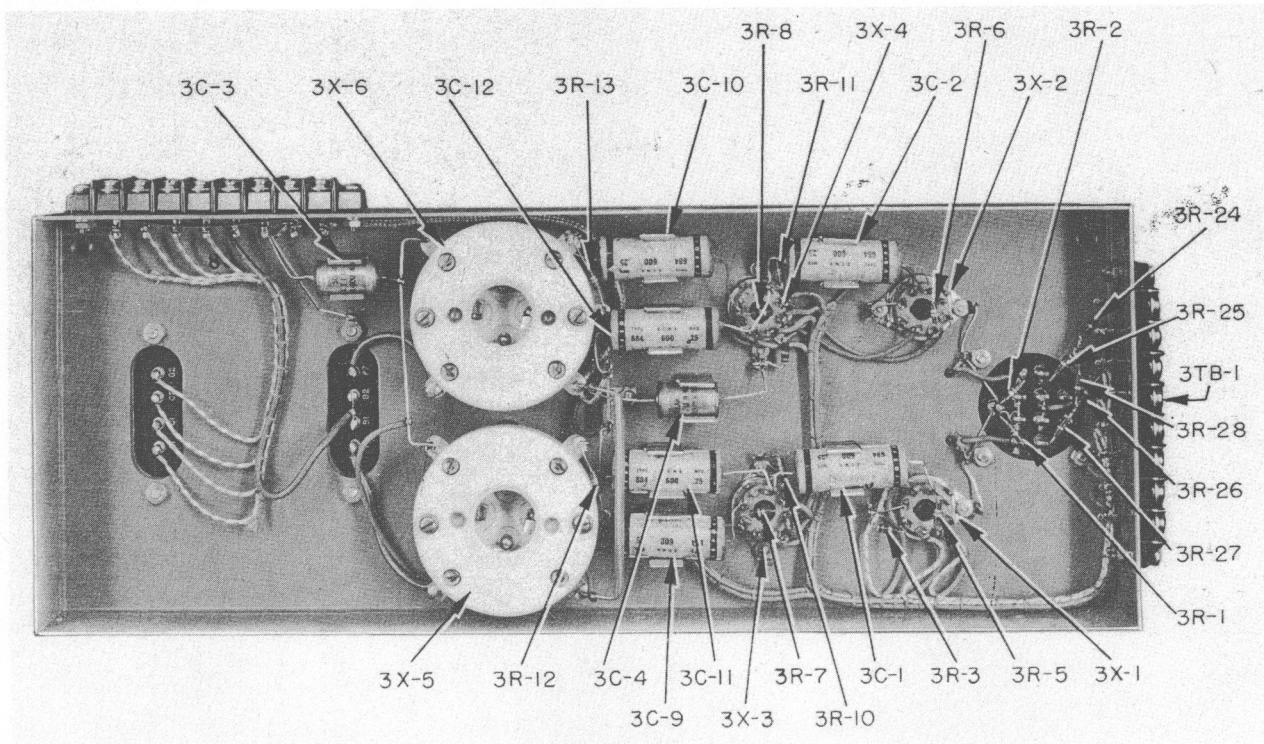

Figure 10. — AF Amplifier Chassis (Bottom).

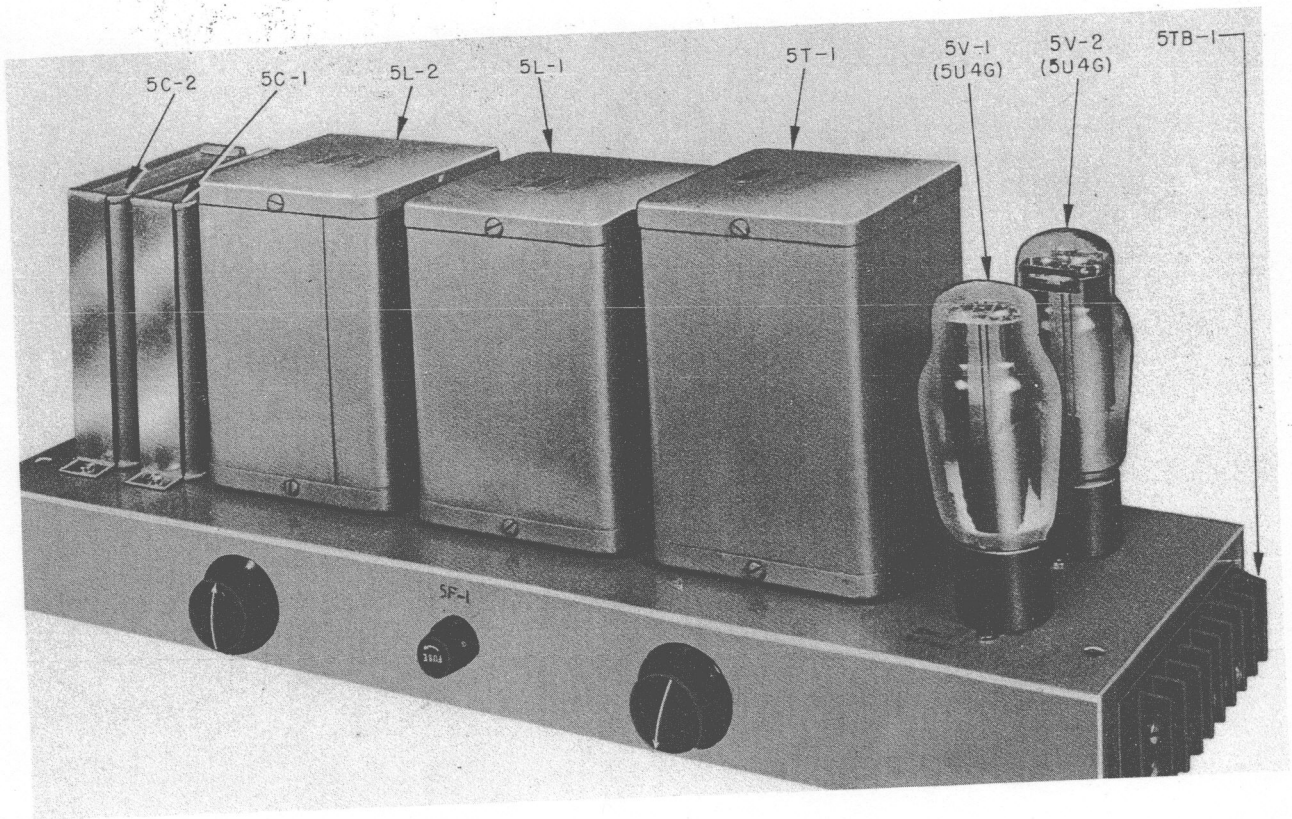

Figure 11. — Modulator Bias Supply (Top).

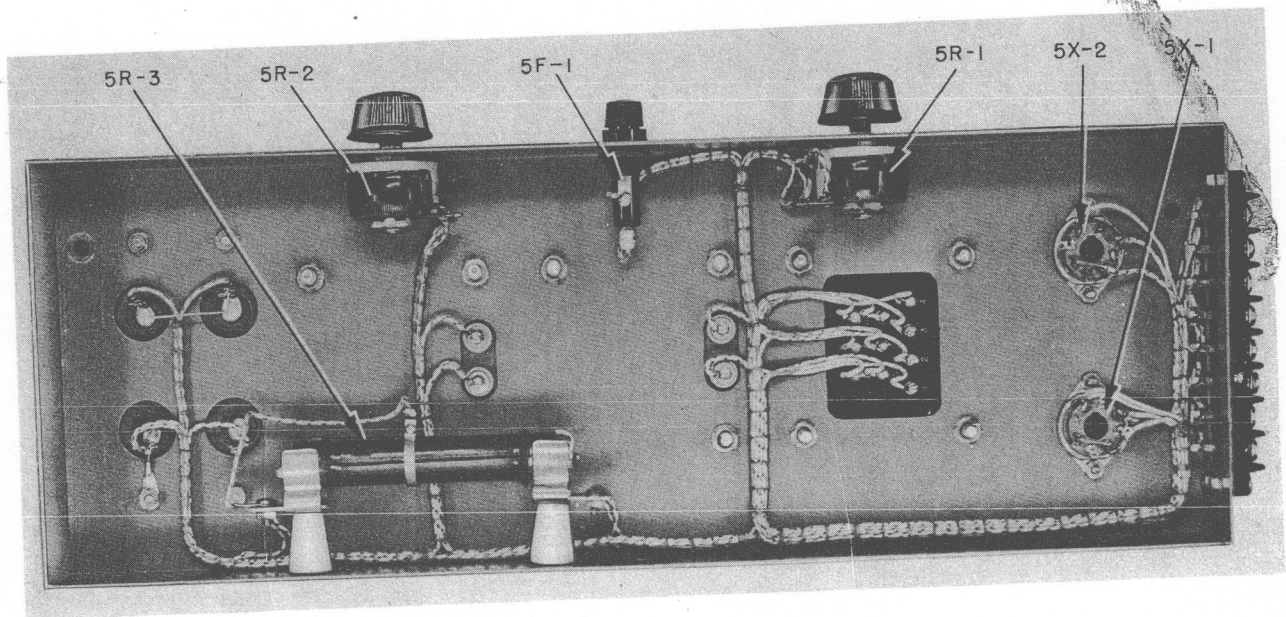

Figure 12. — Modulator Bias Supply (Bottom).

RA-1000A Transmitter

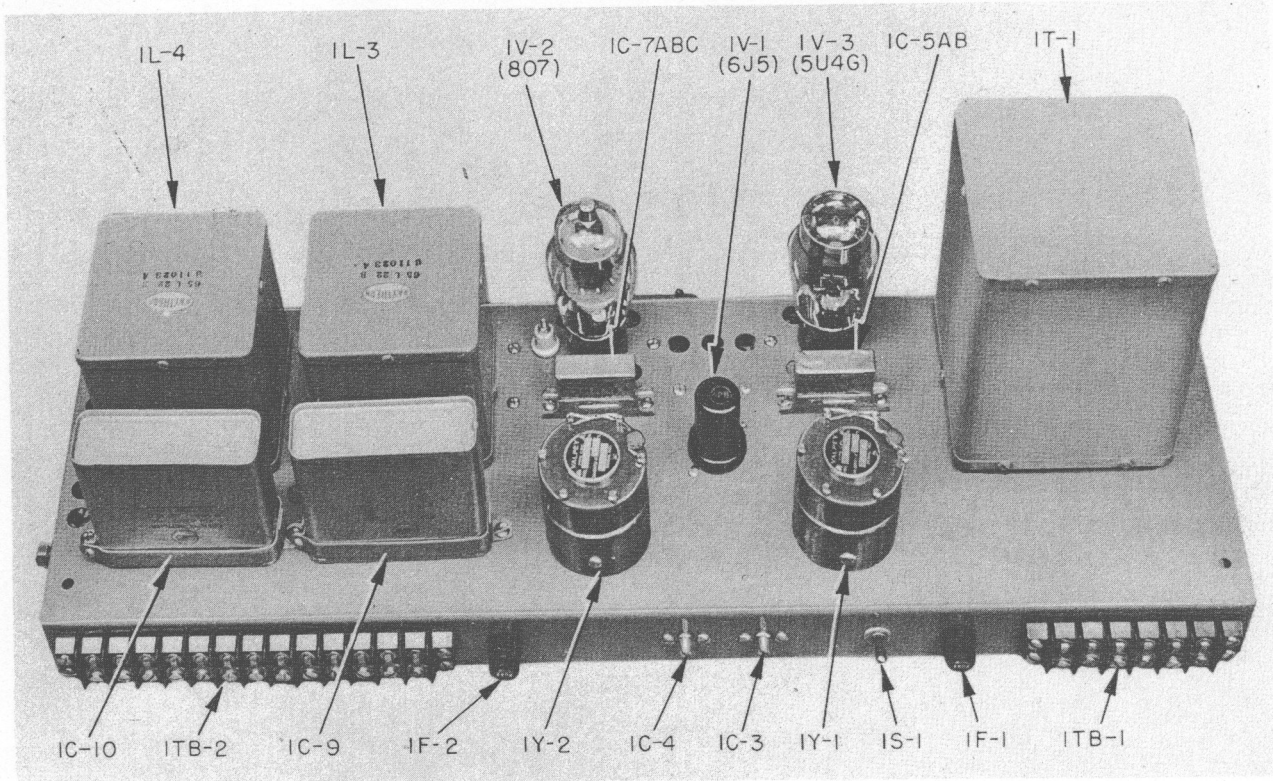

Figure 13. — Exciter Chassis (Top).

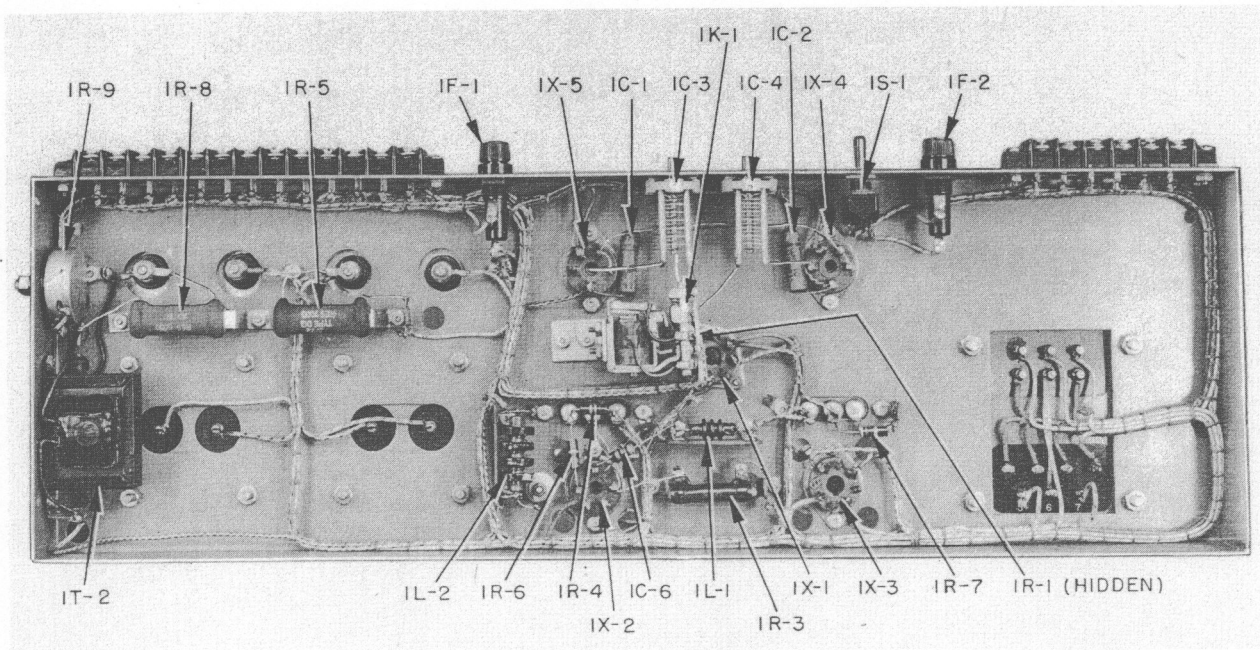

Figure 14. — Exciter Chassis (Bottom).

RA-1000A Transmitter

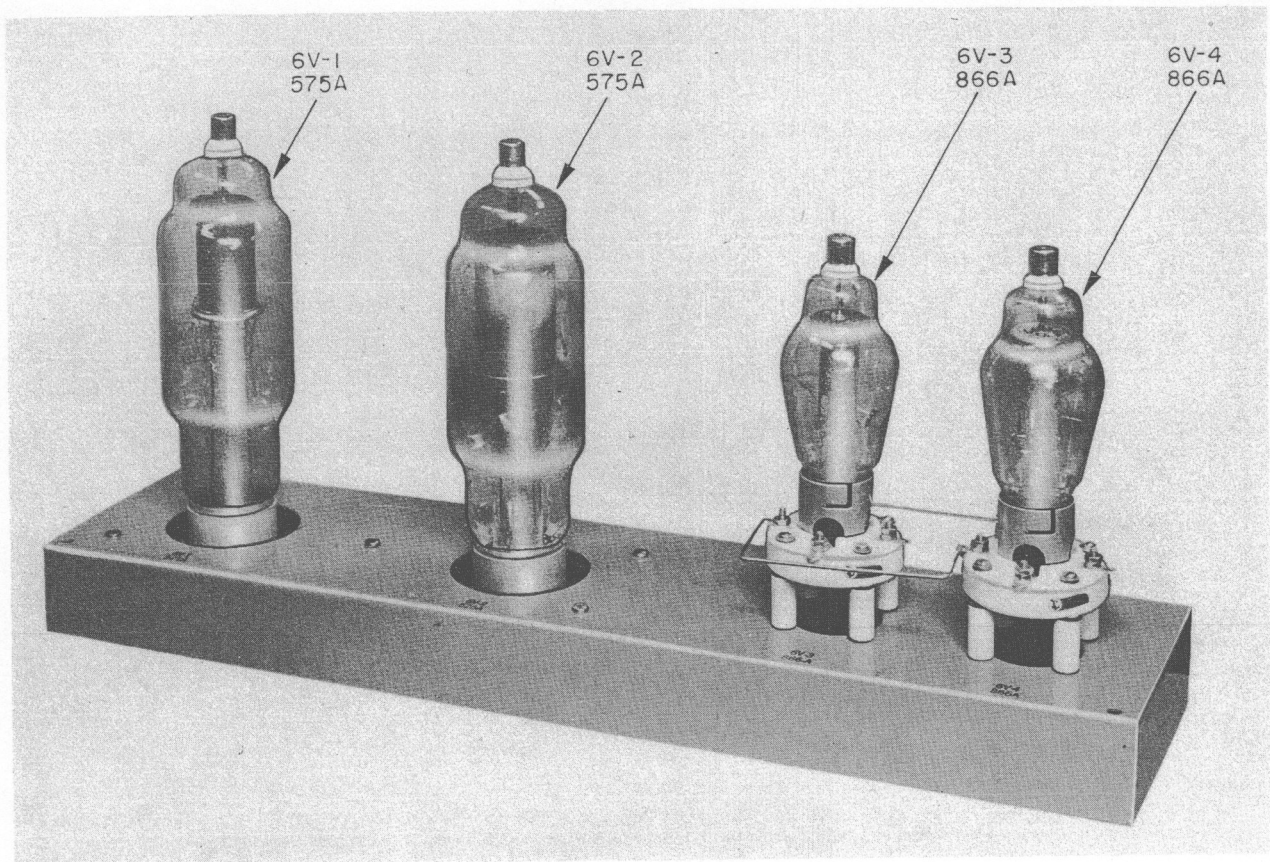

Figure 15. — HV Rectifier Chassis (Top).

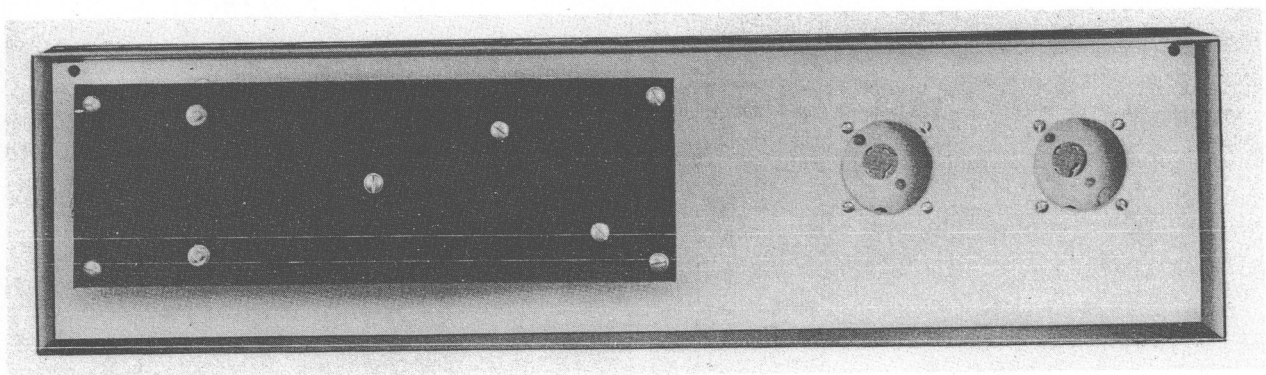

Figure 16. — HV Rectifier Chassis (Bottom).

RA-1000A Transmitter

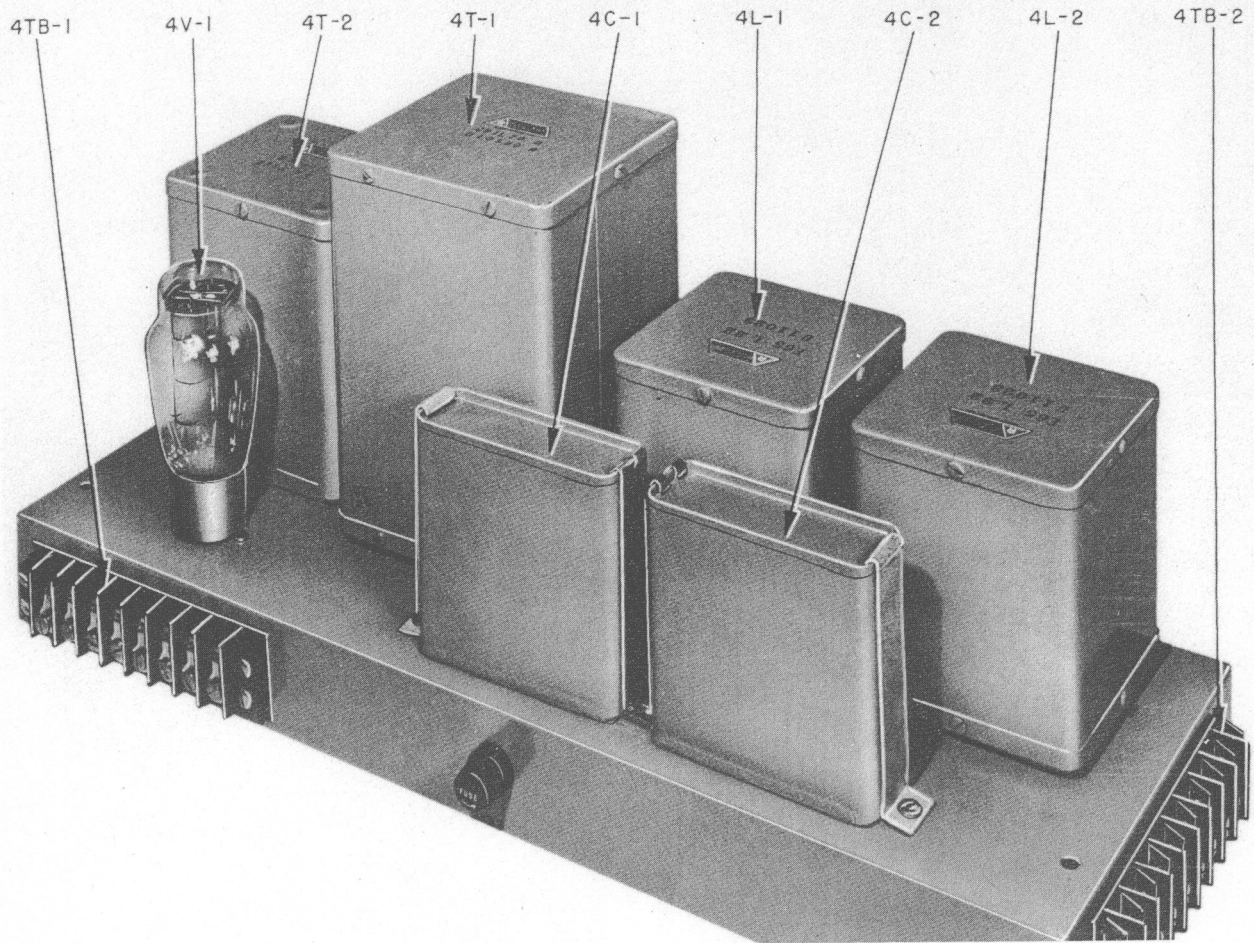

Figure 17. — Modulator Power Supply (Top).

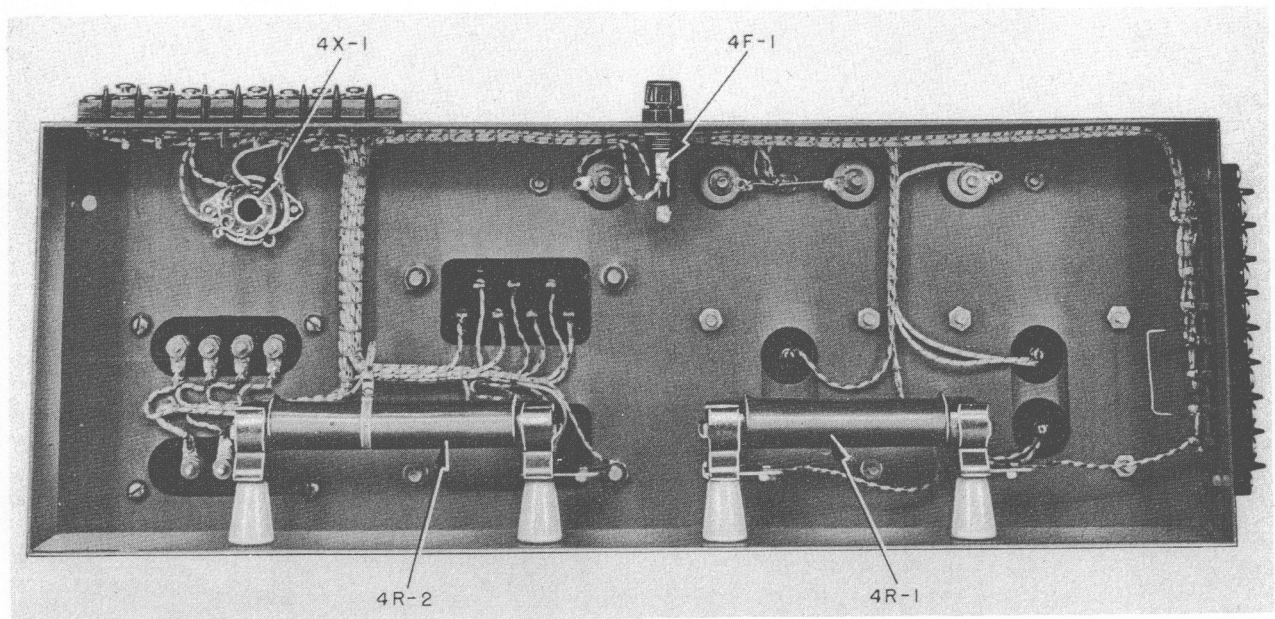

Figure 18. — Modulator Power Supply (Bottom).

RA-1000A Transmitter

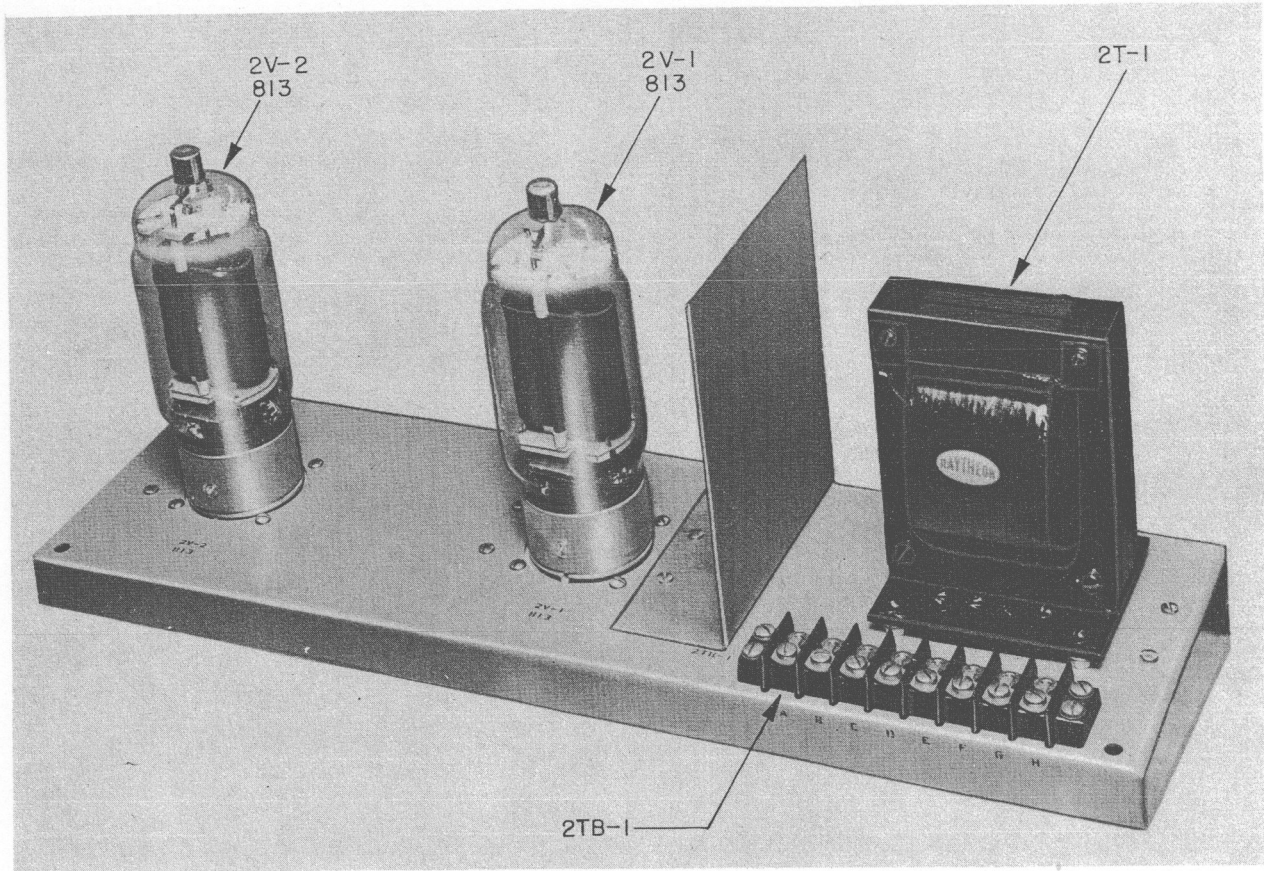

Figure 19. — RF Driver 813 Tube Chassis (Top).

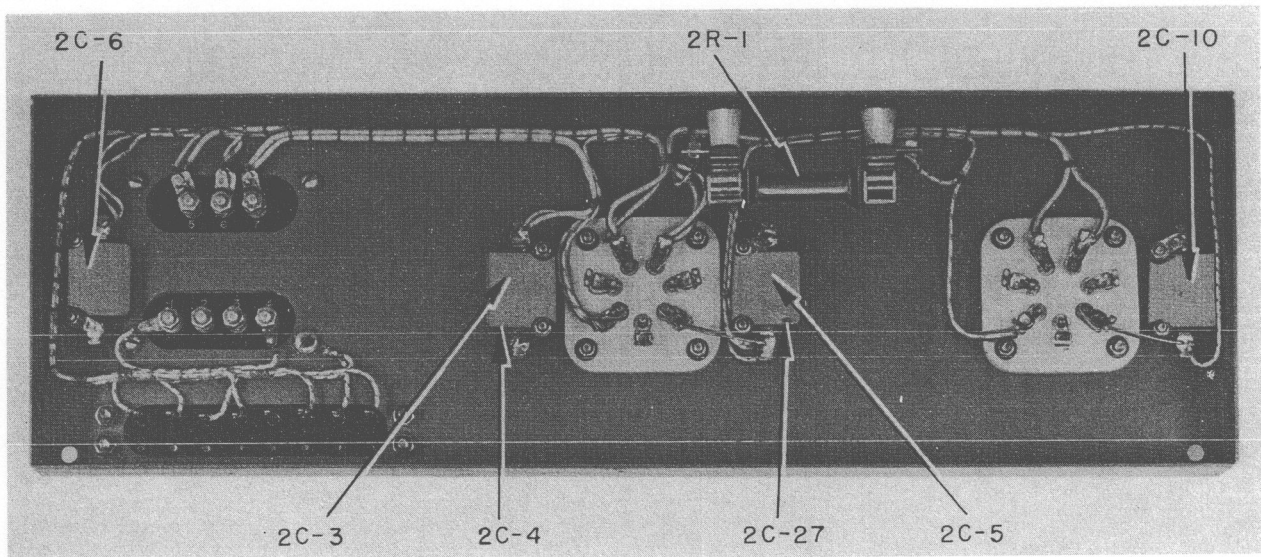

Figure 20. — RF Driver 813 Tube Chassis (Bottom).

RA-1000A Transmitter

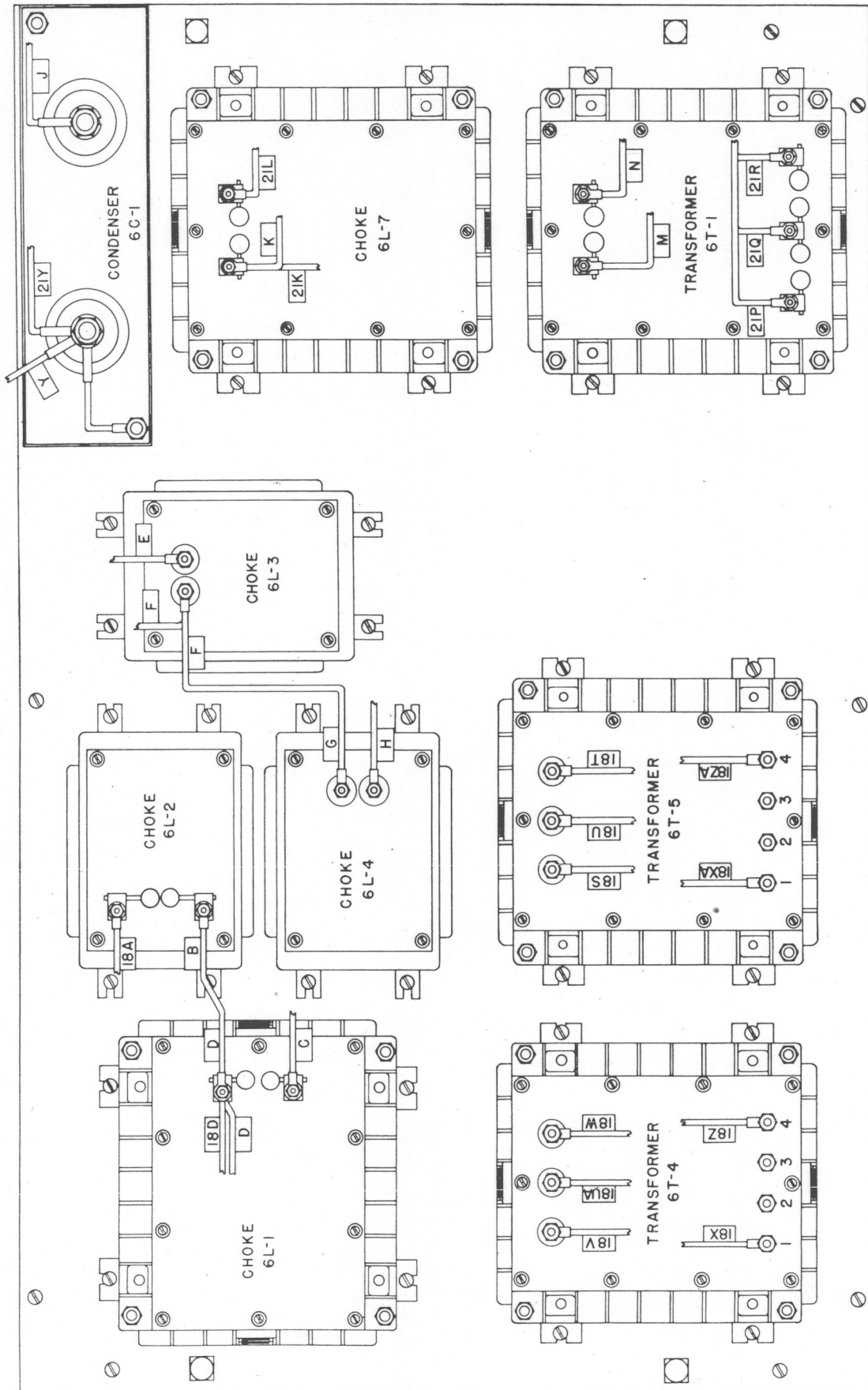

Figure 22. — Base Plate Wiring Diagram.

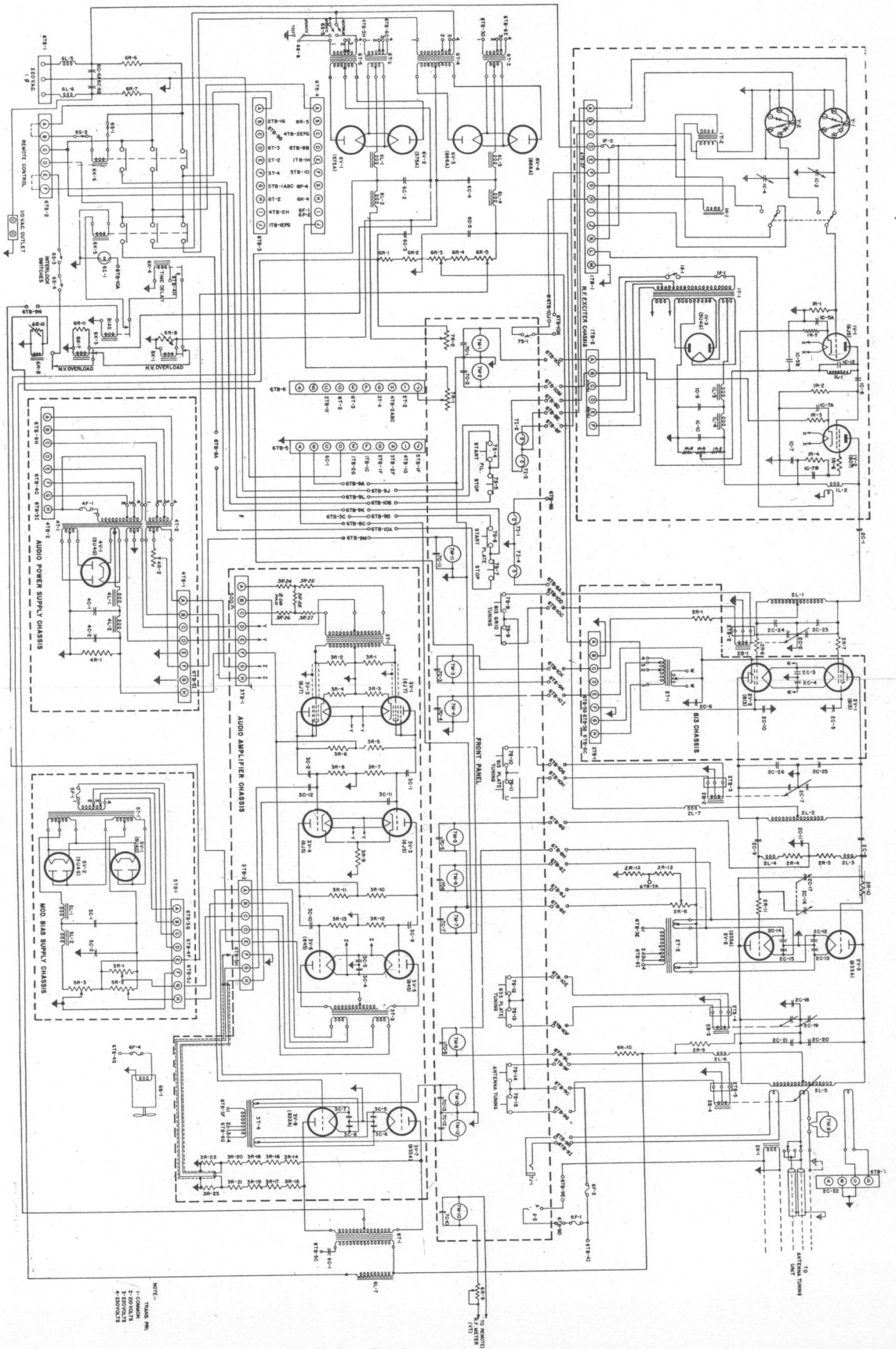
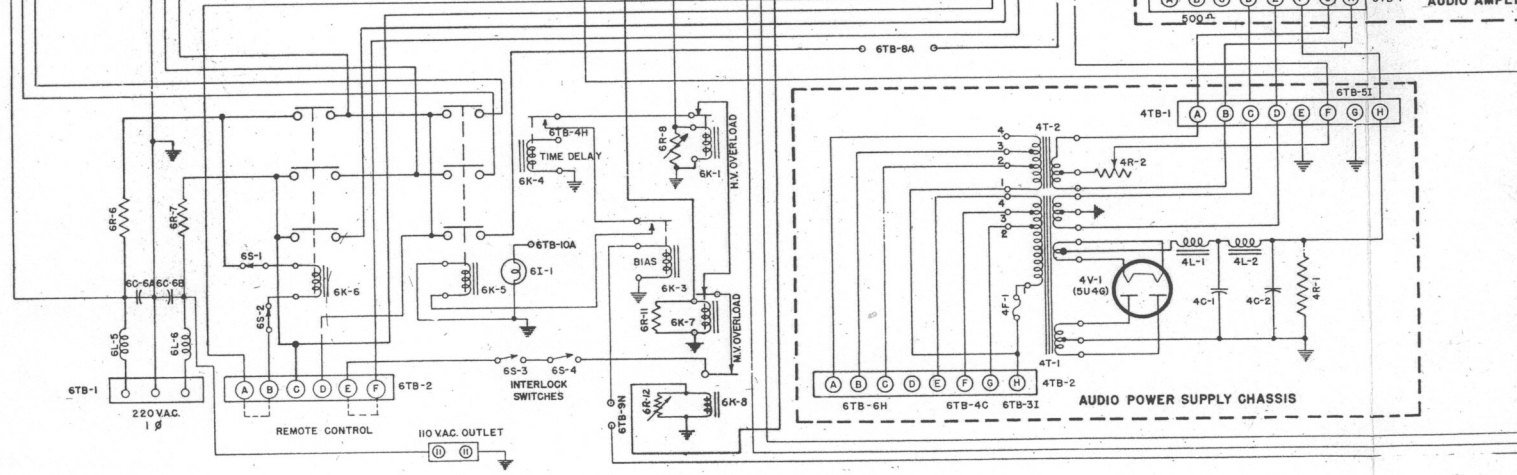
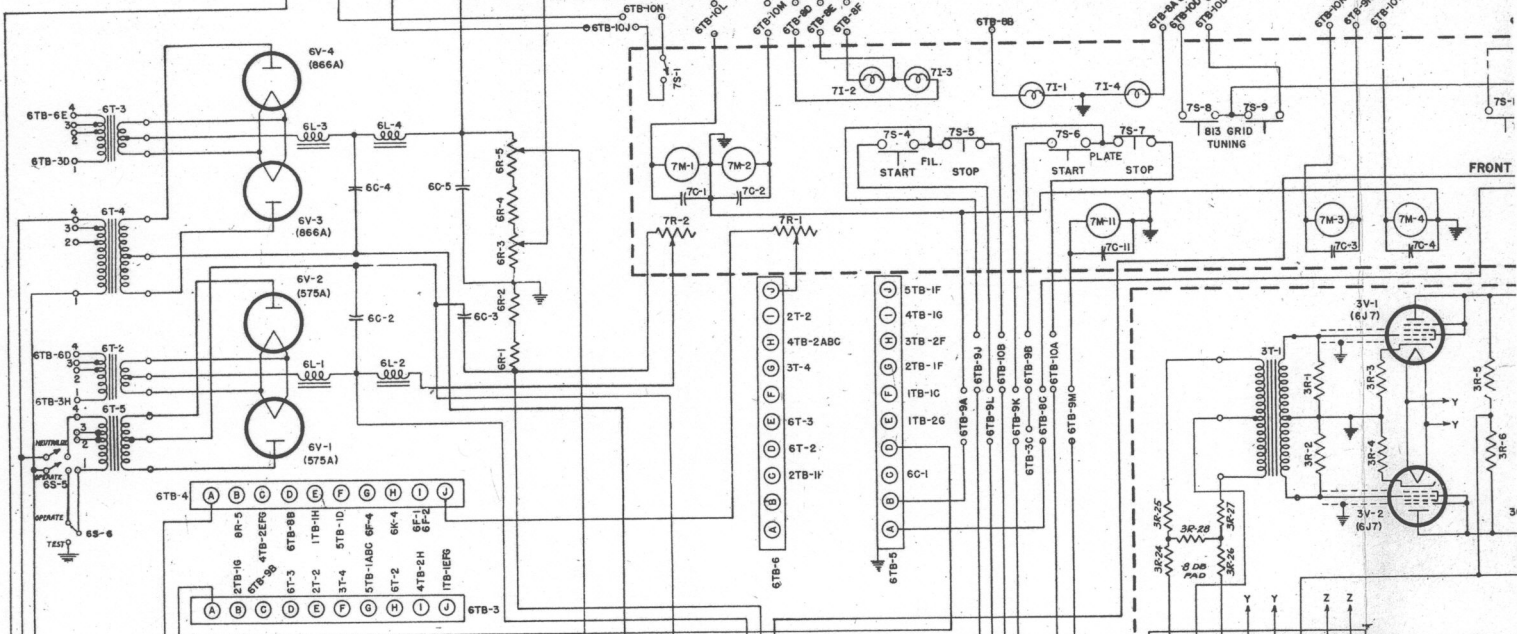
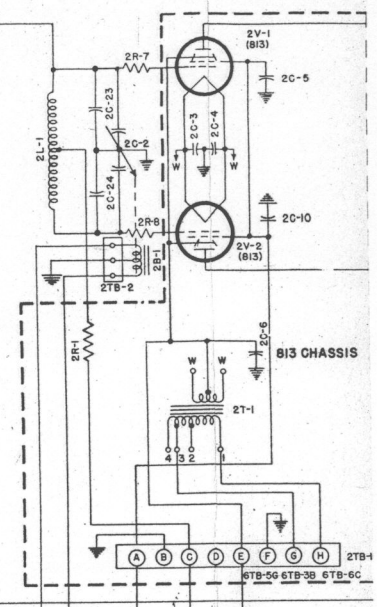
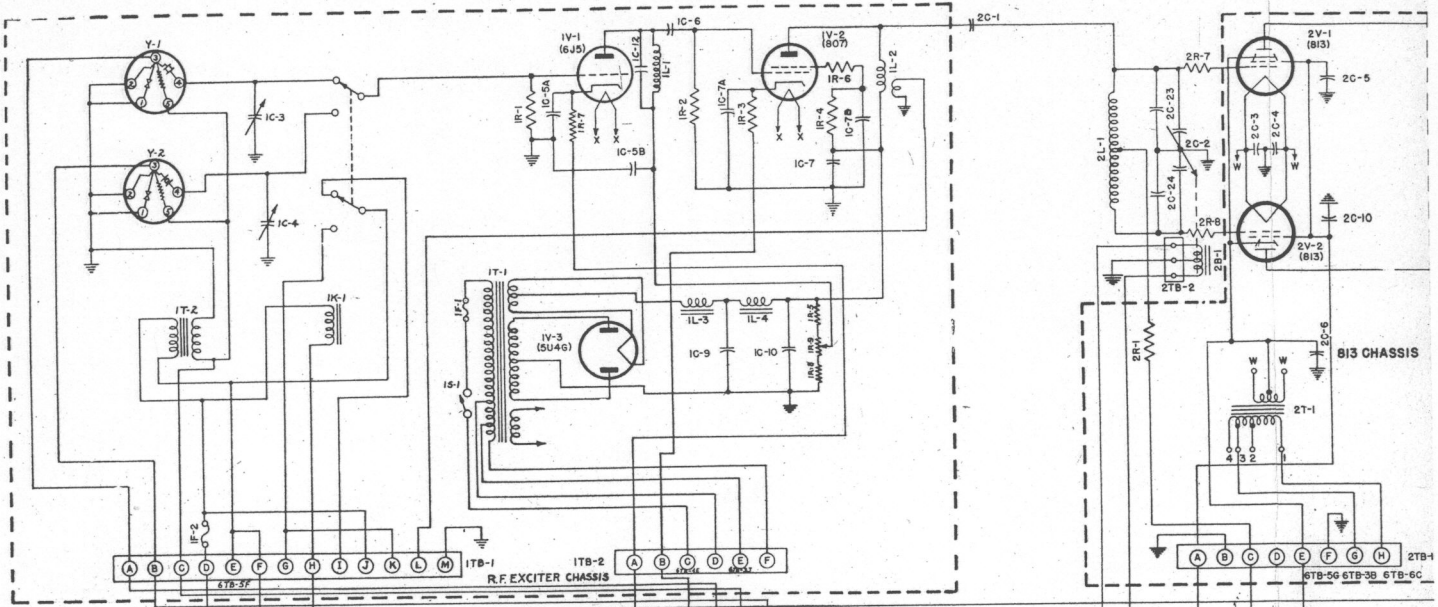

Figure 24. — 1 K.W. A.M. Transmitter.



RA-1000A Transmitter

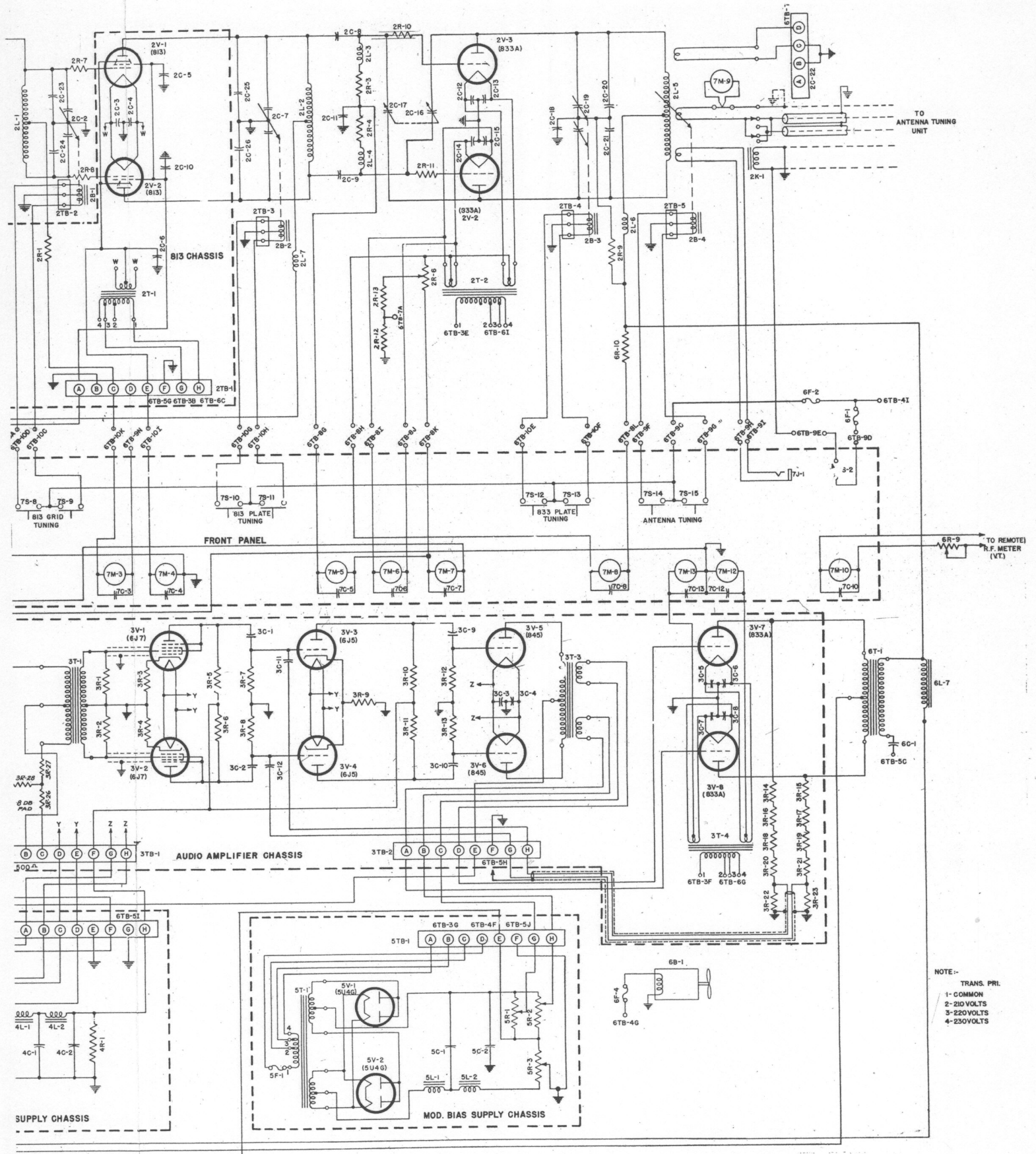

Figure 24. — 1 K.W. A.M. Transmitter.

RA-1000
PARTS LIST

Symbol Desig.	Description and Function	Supplier	Raytheon Part No.
EXCITER CHASSIS			
1C-1	Capacitor, paper, 0.01 mfd. ±5%, 600v, dcw	Aerovox	35-15387
1C-2	Same as 1C-1		
1C-3	Capacitor, 3-30 mmfd., variable air, 0.050 spacing, type J	Johnson	A35-15266
1C-4	Same as 1C-3		
1C-5AB	Capacitor, 3X 0.1 mfd., 600v dcw	Fast	A35-15268
1C-7ABC	Same as 1C-5AB		
1C-6	Capacitor, Ceramicon, 500v. dcw, Type #NPOK. Value (±10%) depends on frequency. To be installed by eng- ineering.	Erie	
1C-9	Capacitor, 8 mfd., 600v dcw., type TJL-6080.	Cornell- Dubilier	A35-15265
1C-10	Same as 1C-9		
1F-1	Fuse, 1 amp., type 3AG	Jefferson	A26-15063
1F-2	Fuse, 1/2 amp., type 3AG	"	A26-15090
1K-1	Relay, Type BJC with coil #39 for 115v ac operation; contacts D.P.D.T.	Allied Control	71-15416
1L-1	RF Choke, Value depends upon freq. 550 kc. to 1059 kc. or 1060 kc. to 1600 kc.	James Millen	A92-15346
1L-2	RF Choke, 4 mh. ± 5%	"	A133-15069
1L-3	Choke, 10 hy., 0.2 amp., filter choke	"	A133-15072
1L-4	Same as 1L-3	Raytheon	A92-15353
1R-1	Resistor, 47,000 ohms ± 10%, 1/2w., type EB	Allen- Bradley	80-15372
1R-2	Resistor, 100,000 ohms ± 10%, 1/2 w. type EB	Allen- Bradley	80-15314
1R-3	Resistor, 350 ohms, 10w., WW, type A119	H.Hindle	A80-15465P2
1R-4	Resistor, 22,000 ohms ± 10%, 1w., type GB	Allen- Bradley	80-15561
1R-5	Resistor, 7,000 ohms, ±10%, 20w. WW. Brown Devil	Ohmite	80-15612

RA-1000
PARTS LIST

Symbol Desig.	Description and Function	Supplier	Raytheon Part No.
EXCITER CHASSIS			
1R-6	Resistor, 56 ohms \pm 10%, 1/2w., type EB.	Allen- Bradley	80-15428
1R-7	Resistor, 470 ohms \pm 10%, 1/2w., type EB	"	80-15440
1R-8	Resistor, 5,000 ohms, 20w., WW. Brown Devil	Ohmite	80-15611
1R-9	Potentiometer, 2,000 ohms, 4w. type M2MP	Mallory	40-15092
1S-11	Switch, 2a., 250v., SPDT, bat handles #8381K7	Cutler- Hammer	A28-15107
1T-1	Transformer, Secs. 5v., 3a.; 6.3v., 6a.; 350v., 0.2a.; #U10590	Raytheon	A92-15377
1T-2	Transformer, Pri. 115v., 60cy.; filament, 6.3v., 2.5a.; type FT-4	UTC	92-15461
1TB-1	Terminal strip, 6 term.	H.B.Jones	A47-15136
1TB-2	" " 13 "	"	47-15051G5
1V-1	Tube, 6J5 metal, crystal osc.		90-15008P1
1V-2	Tube, 807 buffer		90-15093
1V-3	Tube, 5U4G		90-15014P4
1X-1	Socket, octal		A82-15075
1X-2	Socket, 5 prong		A82-15052
1X-3	Same as 1X-1		
1X-4	Same as 1X-2		
1X-5	Same as 1X-2		
1Y-1	Crystal, CBC-0, freq. as specified	Valpey	122-15005
1Y-2	Same as 1Y-1 (extra cost)	KD5OEI	
	Fuse holder		A26-15087
	Fuse holder		A26-15087

RA-1000
PARTS LIST

Symbol Desig.	Description and Function	Supplier	Raytheon Part No.
RF DRIVER & POWER AMPLIFIER SECTIONS			
2B-1	Motor, 115v., 60cy., 10w., 1.7rpm., type #B6400-A, reversible, starting torque 50 in/lbs.	National Scientific Prod. Co.	C-115-15044
2B-2	Same as 2B-1		
2B-3	Same as 2B-1		
2B-4	Same as 2B-1		
2C-1	Capacitor, Mica, 0.005 mfd. \pm 20%, 600v., dcw, type H or type 4	Sangamo or Cornell- Dubilier	A35-15263
2C-3	Capacitor, mica, 0.1 mfd. \pm 20%, 600v., dcw, type H-1110	Sangamo	A35-15122
2C-4	Same as 2C-3		
2C-5	Same as 2C-3		
2C-6	Same as 2C-3		
2C-7	Capacitor, variable air, 22-150 mmfd., #150 DD-45	Johnson	C35-15279
2C-8	Capacitor, mica, 0.0001 mfd. \pm 20%, 5000v., dcw, type 1654L	Aerovox	A35-15269
2C-9	Same as 2C-8		
2C-10	Same as 2C-3		
2C-11	Capacitor, mica, 0.005 mfd. \pm 20%, 500v., dcw, type HL or 4	Sangamo or Cornell- Dubilier	A35-15264
2C-12	Same as 2C-3		
2C-13	Same as 2C-3		
2C-14	Same as 2C-3		
2C-15	Same as 2C-3		
2C-16	Capacitor, variable, 12 mmfd., #12C-110	Cornell- Dubilier E.F. Johnson	B35-15273
2C-17	Same as 2C-16		
2C-18	Capacitor, 0.005 mfd. \pm 20%, 8000v., peak working voltage, type F3	Sangamo	A35-15395P8
2C-19	Capacitor, variable air, consists of 2 32-103 mmfd., #100C110	Johnson	C35-15281
2C-20	Capacitor, ferrule type, vacuum, 10,000v., (capacity determined by trans. frequency)	Gen.Elec., Jennings, or Raytheon	50 U 71 A

RA-1000
PARTS LIST

Symbol Desig.	Description and Function	Supplier	Raytheon Part No.
RF DRIVER & POWER AMPLIFIER SECTIONS			
2C-21	Same as 2C-20		
2C-23	Capacitor, 5000v. test. Sangamo type A2L or Cornell type 9. (Values determined by transmitter frequency.)	Sangamo or Cornell-Dubilier	
2C-24	Same as 2C-23		
2C-25	Capacitor, type F3. (Values determined by Transmitter frequency.)	Sangamo	
2C-26	Same as 2C-25		
2K-1	Relay, 117v., DPDT, #1527 (antenna change-over)	Leach	A71-15328
2L-1	Coil, 200 μ h. (fabricated) (813 grid & 813 plate)	Raytheon	B51-15574
2L-2	Same as 2L-1		
2L-3	Choke, 5mh. RFC, 500 Ma., dc, #278 (833's grid & 813 plate)	I.C.A.	A92-15344
2L-4	Choke, 5 mh. RFC, 500 Ma., dc, #278 (833's grid & 813 plate)	I.C.A.	A92-15344
2L-5	Coil, variable link inductor (rf plate & antenna coupling) <u>Frequency Kc.--Ind. JH.</u> 1600 — 800 135 800 — 540 240 (Value depends upon frequency)		B133-15043 D133-15045
2L-6	Choke, 2.8 mh. RFC, 1a, dc, #266 833 rf plate	I.C.A.	A92-15347
2L-7	Same as 2L-4		
2R-1	Resistor, ferrule, 15000 ohms, 18w., WW, mtg. 2-15/16", type A20-9	Ohmite	A80-15497P1
2R-3	Resistor, ferrule, 4000 ohms, 45w., WW, mtg. 5-1/8", type L20-13	H.Hindle	B80-15558
2R-4	Same as 2R-3		
2R-6	Resistor, ferrule, 250 ohms, 110w., WW, mtg. 7-7/16", type V20-18	"	B80-15497P1
2R-7	Resistor, 50 ohms, 0.3 μ h., #P-300, parasitic suppressor	Ohmite	A80-15464
2R-8	Same as 2R-7		

RA-1000
PARTS LIST

Symbol Desig.	Description and Function	Supplier	Raytheon Part No.
------------------	--------------------------	----------	----------------------

RF DRIVER & POWER AMPLIFIER SECTIONS

2R-9	Resistor, 220,000 ohms \pm 20%, 2 watts	Allen- Bradley	80-15630
2R-10	Resistor, ferrule, 100 ohms, 13 w., type A20-9-2 3/8	H.Hindle	A80-15460
2R-11	Same as 2R-10		
2R-12	Resistor, carbon, 510 ohms \pm 5%, 1 w.	Allen- Bradley	80-15738
2R-13	Resistor, carbon, 100K \pm 5%, 1 w.	Allen- Bradley	80-15145
2T-1	Transformer, filament, 10v., 10a., 813 Filament	Raytheon	A92-15465
2T-2	Transformer, filament, 10v., 10a; 10v., 10a., #U-10930, 833 filament	Raytheon	92-15475
2TB-1	Terminal Board #8-142 YMS	H.B. Jones	A47-15071
2TB-2	Terminal Board #3-141 YMS	H.B. Jones	A47-15069
2TB-3	Same as 2TB-2		
2TB-4	Same as 2TB-2		
2TB-5	Same as 2TB-2		
2V-1	Tube, 813 rf driver	RCA	90-15094
2V-2	Same as 2V-1		
2V-3	Tube, 833A, rf power amplifier	RCA	90-15107
2V-4	Same as 2V-3		
2X-1	Socket, wafer "813", #237	Johnson	A82-15035
2X-2	Same as 2X-1		
2X-3	Socket, "833A", #124-212	Johnson	B82-15080
2X-4	Same as 2X-3		

CONTROL AND METER PANELS

7C-1 through 7C-13	Capacitor, mica, 0.005 mfd. \pm 20%, 600v., dcw., type HL or type 4	Sangamo or Cornell- Dubilier	A35-15264
--------------------------	---	---------------------------------------	-----------

RA-1000
PARTS LIST

Symbol No.	Description and Function	Supplier	Raytheon Part No.
CONTROL AND METER PANELS			
7I-1	Lamp, 120v., 6w., candelabra base, type 6S-6	Mazda	A77-15008
7I-2	Same as 7I-1		
7I-3	Same as 7I-1		
7I-4	Same as 7I-1		
7J-1	Jack, closed circuit, type #2A	Utah	A76-15029
7M-1	Meter, grid, 0-15 ma. dc., #301, 3-1/2" rectangular case, osc. plate and rf driver	Weston	C45-15121 P3
7M-2	Meter, 0-100 ma. dc., #301, 3-1/2" rectangular case, buffer plate	Weston	C45-15121 P4
7M-3	Same as 7M-1		
7M-4	Meter, 0-250 ma. dc., #301, 3-1/2" rectangular case, rf driver plate	Weston	" P6
7M-5	Meter, 0-250 ma. dc., #741, 4-1/4" rectangular case, final grid	Weston	C45-15119 P12
7M-6	Meter, 0-15v. ac, #744, 4-1/4" rectangular case, filament	Weston	C45-15120
7M-7	Meter, 0-1a. dc, #741, 4-1/4" rectangular case, final plate	Weston	C45-15119 P14
7M-8	Meter, 0-4 kv. dc, #741, 4-1/4" rectangular case, final plate	Weston	C45-15119 P9
7M-9	Meter, 0-5a., rf ammeter, Model #743 Rectangular bakelite case having external thermocouple, calibrated for use with 44" unshielded twisted leads & supplied with leads. Meter calibrated for use on 16 gauge steel panel.	Weston	45-15097
7M-10	Meter, 0-1 ma. movement, #741, 4-1/4" rectangular case, less scale, Antenna	Weston	B45-15074
7M-11	Same as 7M-4		
7M-12	Meter, 0-500 ma. dc., #741, 4-1/4" rectangular case, Modulator plate	Weston	C45-15119
7M-13	Same as 7M-12		

RA-1000
PARTS LIST

Symbol No.	Description and Function	Supplier	Raytheon Part No.
CONTROL AND METER PANELS			
7R-1	Rheostat, WW, 3 ohms, 150w., type D.	H.Hindle	A40-15063
7R-2	Rheostat, WW, 500 ohms, 300w., type E	H.Hindle	B40-15069
7S-1	Switch, toggle, bat handle, SPST, 3a., 250v., black oxidized finish, #83B1K7, crystal change-over and antenna change	Cutler-Hammer	A28-15107
7S-2	Same as 7S-1		
7S-4	Switch, normally open, black, push button, type B-1	A.H. & H.	A28-15125P1
7S-5	Switch, push button, normally closed, red, type B-3	A.H. & H.	A28-15125P2
7S-6	Same as 7S-4		
7S-7	Same as 7S-5		
7S-8	Same as 7S-4		
through 7S-15			
AUDIO AMPLIFIER AND MODULATOR			
3C-1	Capacitor, paper, tubular, 0.25 mfd., 600v., dcw., type DT #6P-25	Cornell-Dubilier	A35-15262
3C-2	Same as 3C-1		
3C-3	Capacitor, oil, 0.01 mfd., 600v., #A8240BA	J.Fast	A35-15272
3C-4	Same as 3C-3		
3C-5	Capacitor, mica, 0.01 mfd. \pm 20%, 600v., dcw., #H-1110	Sangamo	A35-15122
through 3C-8			
3C-9	Same as 3C-1		
through 3C-12			
3R-1	Resistor, 27,000 ohms \pm 10%, 1/2w., type EB	Allen-Bradley	80-15408
3R-2	Same as 3R-1		
3R-3	Resistor, 3300 ohms \pm 10%, 1/2w., type EB	"	80-15610
3R-4	Same as 3R-3		

RA-1000
PARTS LIST

Symbol No.	Description and Function	Supplier	Raytheon Part No.
AUDIO AMPLIFIER AND MODULATOR			
3R-5	Resistor, 100,000 ohms \pm 10%, 1/2w., type EB	Allen-Bradley	80-15314
3R-6	Same as 3R-5	"	80-15467
3R-7	Resistor, 270,000 ohms \pm 10%, 1/2w., type EB	"	80-15467
3R-8	Same as 3R-7	"	80-15408
3R-9	Same as 3R-3	"	80-15408
3R-10	Same as 3R-5	"	80-15408
3R-11	Same as 3R-5	"	80-15408
3R-12	Same as 3R-7	"	80-15408
3R-13	Same as 3R-7	"	80-15408
3R-14 through 3R-21	Resistor, 2.2 megs. \pm 10%, 2w., type HB	Allen-Bradley	80-15659
3R-22	Resistor, 47,000 ohms \pm 10%, 1w., type GB	"	80-15315
3R-23	Same as 3R-22	"	80-15418
3R-24 through 3R-27	Resistor, 120 ohms \pm 10%, 1/2w., type EB	"	80-15418
3R-28	Resistor, 560 ohms \pm 10%, 1/2w., type EB	"	80-15419
3T-1	Transformer, #94191, RC-75 case, audio line to grid	UTC	A92-15329
3T-3	Transformer, #U10936, driver 845's "A" to 833's "B"	Raytheon	A92-15386
3T-4	Transformer, #U10930, filament 10v., 10a.; 10v. 10a.; 833 mod. fil.	Raytheon	92-15475
3TB-1	Terminal Board - #8-142YMS	H.B.Jones	A47-15071
3TB-2	Same as 3TB-1		
3V-1	Tube, 6J7, metal, 1st a.f. amplifier	RCA	90-15056P1
3V-2	Same as 3V-1		
3V-3	Tube, 6J5, metal, 2nd a.f. amplifier	RCA	90-15008P1
3V-4	Same as 3V-3		
3V-5	Tube, 845, push-pull a.f. driver	RCA	90-15108
3V-6	Same as 3V-5		
3V-7	Tube, 833A, modulator	RCA	90-15107
3V-8	Same as 3V-7		

RA-1000
PARTS LIST

Symbol No.	Description and Function	Supplier	Raytheon Part No.
<u>AUDIO AMPLIFIER AND MODULATOR</u>			
3X-1 through 3X-4	Socket, 8 pin octal, mica filled centers, 1- $\frac{1}{2}$ " mtg., #9859	Cinch	A82-15075
3X-5	Socket, 50 watts, #123-211	Johnson	A82-15018
3X-6	Same as 3X-5		
3X-7	Socket, 833A, #124-212	Johnson	B82-15080
3X-8	Same as 3X-7		
<u>MODULATOR POWER SUPPLY</u>			
4C-1	Capacitor, oil, 8 mfd., 600v., dcw., type TJJ 6080	Cornell-Dubilier	A35-15265
4C-2	Same as 4C-1		
4F-1	Fuse, 1-1/2 a., type 3AG	Jefferson	A26-15070
4L-1	Choke, 10 hy., 0.2a., #U11023, filter audio power supply	Raytheon	A92-15353
4L-2	Same as 4L-1		
4R-1	Resistor, ferrule type, WW, 5000 ohms, 38w., mtg. 4-7/16", L20-13	H.Hindle	A80-15463
4R-2	Resistor, ferrule type, WW, 2000 ohms, 45w., adj. slider, mtg. 5-1/8", L20-13	H.Hindle	B80-15495
4T-1	Transformer, power, 350v. 0.2a.; 5v., 3a.; 6.3v. 6a.; #U10590 audio power supply	Raytheon	A92-15377
4T-2	Transformer, filament, 10v., 10a., #M-10933, 845 filament	Raytheon	A92-15381
4TB-1	Terminal board #8-142YMS	H.B.Jones	A47-15071
4TB-2	Same as 4TB-1		
4V-1	Tube, 5U4G, rectifier	RCA	90-15014P4
4X-1	Socket, 8 pin octal, mica filled centers, with 1 $\frac{1}{2}$ " mtg., #9859	Cinch	A82-15075
<u>MODULATOR BIAS SUPPLY</u>			
5C-1	Capacitor, oil, 8 mfd., 600v., TJJ 6080	Cornell-Dubilier	A35-15265
5C-2	Same as 5C-1		

RA-1000
PARTS LIST

Symbol No.	Description and Function	Supplier	Raytheon Part No.
MODULATOR BIAS SUPPLY			
5F-1	Fuse, 1-1/2a., type 3AG	Jefferson	A26-15070
5L-1	Choke, 3.5 hy., 0.4a., dc, #U10929, modulator bias supply filter	Raytheon	A92-15354
5L-2	Same as 5L-1		
5R-1	Resistor, potentiometer, WW, 100 ohms, 25w., type A	H.Hindle	A40-15064
5R-2	Same as 5R-1		
5R-3	Resistor, ferrule type, WW, 200 ohms, 38w., adj. slider, mtg. 4-7/16", L20-13	H.Hindle	A80-15462
5T-1	Transformer, power, 80v., dc, 0.4a; 5v., 6a.; #U10932, mod. bias power	Raytheon	A92-15382
5TB-1	Terminal board, #8-142YMS	H.B.Jones	A47-15071
5V-1	Tube, 5U4G, rectifier	R.C.A.	90-15014P4
5V-2	Same as 5V-1		
5X-1	Socket, 8 pin octal, mica filled centers, 1-1/2" mtg., #9859	Cinch	A82-15075
5X-2	Same as 5X-1		
<u>HIGH VOLTAGE POWER SUPPLY AND RELAY CIRCUITS</u>			
6B-1	Cooling fan, #S47120 2L, medium pressure flow, model A, cabinet fan per dwg.	Rotron	B115-15059P3
6C-1	Capacitor, oil, 4 mfd., 750v., dcw.	#7520 Aerovox 700400 C.D.#TK	C35-15277
6C-2	Capacitor, consists of two 2 mfd., 5000v., dcw., oil, type TJJ, or one single 4 mfd., type TJJ, 5000v., dcw., oil	Cornell- Dubilier	C35-15278
6C-3	Same as 6C-2		
6C-4	Capacitor, oil, 4 mfd., 3000v., dcw	Cornell- Dubilier #T-30040 TJJ	B35-15274

RA-1000
PARTS LIST

Symbol No.	Description and Function	Supplier	Raytheon Part No.
HIGH VOLTAGE POWER SUPPLY AND RELAY CIRCUITS			
6C-5	Same as 6C-4		
6C-6AB	Capacitor, dual type, 2 x 0.1 mfd., 600v., dcw, DYR	Cornell- Dubilier DYR-6011	A35-15130
6F-1	Fuse, 1/2a., type 3AG	Jefferson	A26-15090
6F-2	Fuse, 1-1/2a., type 3AG	Jefferson	A26-15070
6F-4	Same as 6F-2		
6I-1	Lamp, 120v., 6w., candelabra, type 6S-6	Mazda	A77-15008
6K-1	Relay, 3v., 6 ohms, DPST, #1252 h.v. + med. overload	Leach	A71-15330
6K-3	Relay, 60v., dc, DPST, #1251, modulator bias	Leach	A71-15329
6K-4	Relay, time-delay, 117v., ac., SPST, 30 sec. timer, front connected, type TD-2	Cramer	C71-15332
6K-5	Contactator, 3 pole, form S, 110v. 60 cy. coil, class 8502, type S0-10, size 1.	Square D	A71-15425
6K-6	Contactator, 3 pole, form S, 220v. 60 cy. coil, AR-40 heater, Class 8536, type SA0-3, size 1	Square D	A71-15446
6K-7	Same as 6K-1		
6K-8	Same as 6K-1		
6L-1	Choke, swinging, 5-9 hy. @1.25-0.7a., h.v. filter	#U11412 Raytheon	A92-15351
6L-2	Choke, smoothing, 7 hy., 0.7a., h.v. filter	#U11411 Raytheon	A92-15350
6L-3	Choke, smoothing, 12 hy., 0.5a., med. h.v. filter	#U11062 Raytheon	A92-15352
6L-4	Same as 6L-3		
6L-5	Choke, r.f., PW-3, a.c. line	Lectrohms	A92-15348
6L-6	Same as 6L-5		
6L-7	Choke, 60 hy., 0.6a., modulation reactor	#U10935 Raytheon	A92-15349

RA-1000
PARTS LIST

Symbol No.	Description and Function	Supplier	Raytheon Part No.
HIGH VOLTAGE POWER SUPPLY AND RELAY CIRCUITS			
6R-1	Resistor, ferrule type, WW, 30,000 ohms, 110w., mtg. 4-7/16", L20-13	H.Hindle	B80-15496P2
6R-2	Same as 6R-1		
6R-3	Resistor, ferrule type, 7000 ohms, 110w., adj. slider, mtg. 4-7/16", V20-18	H.Hindle	B80-15497P2
6R-4	Resistor, ferrule type, 7000 ohms, 110w., V20-18, mtg. 7-7/16"	H.Hindle	B80-15496P1
6R-5	Resistor, ferrule type, 2500 ohms, 200w., adj. slider, mtg. 11-1/2"	H.Hindle	B80-15493
6R-6	Thermal overload heaters	A.H. & H.	A71-15314
6R-7	Same as 6R-6		
6R-8	Resistor, ferrule type, WW, 3 ohms 18w., mtg. 2-15/16", A20-9	H.Hindle	A80-15466P1
6R-9	Potentiometer, WW, 20 ohms, type T	Mallory	A40-15066
6R-10	Resistor, vacuum ferrule, 4 megs., for use with 0-4 kv. meter	Weston	B80-15494
6R-11	Resistor, vitreous enamel, WW, 2 ohms, 10w., type A	H.Hindle	A80-15465P1
6R-12	Resistor, ferrule type, WW, adj. slider, 15 ohms \pm 10%, 18w., 2-15/16", A20-9	H.Hindle	80-15539
6S-3	Switch, interlock, SPST, type YZ-RQ1 N	Micro-switch	A28-15120
6S-4	Same as 6S-3		
6S-5	Switch, DPST, 250v., 20a., #7402K3, neutralizing	Cutler-Hammer	A28-15086
6S-6	Switch, DPDT, 250v., 10a.	A.H. & H.	28-15174
6T-1	Transformer, class B modulation, 800w., #U10937	Raytheon	B92-15389
6T-2	Transformer, filament, 5v., 20a., #M10931, 575A filament	Raytheon	92-15463
6T-3	Transformer, filament, 2.5v., 10a., 866 filament	Raytheon	92-15464
6T-4	Transformer, for 1500v. 425 ma. dc. supply, med. h.v. plate	Raytheon	A92-15387
6T-5	Transformer, for 2750v. 1.25a. dc. supply, h.v. plate	Raytheon	A92-15385

RA-1000
PARTS LIST

Symbol No.	Description and Function	Supplier	Raytheon Part No.
HIGH VOLTAGE POWER SUPPLY AND RELAY CIRCUITS			
6TB-1	Terminal board #3-151MS	H.B.Jones	A47-15070
6TB-2	Terminal board, #6-142MS	"	A47-15003
6TB-3	Terminal board, ac distribution (fab.)	Raytheon	B51-15576
6TB-4	Same as 6TB-3		
6TB-5	Same as 6TB-3		
6TB-6	Same as 6TB-3		
6TB-7	Terminal board, #4-142MS	H.B.Jones	A47-15072
6TB-8	Terminal board, #14-142MS	H.B.Jones	A47-15212
6TB-9	Same as 6TB-8		
6TB-10	Same as 6TB-8		
6V-1	Tube, 575A, h.v. rectifier	R.C.A.	90-15054
6V-2	Same as 6V-1		
6V-3	Tube, 866A, a.c. and r.f. power supply rectifier	"	90-15023
6V-4	Same as 6V-3		
6X-1	Socket, 50w., #211	Johnson	A82-15018
6X-2	Same as 6X-1		
6X-3	Socket, #209	"	A82-15073
6X-4	Same as 6X-3		